

ME series DVR User's installation and operation Manual

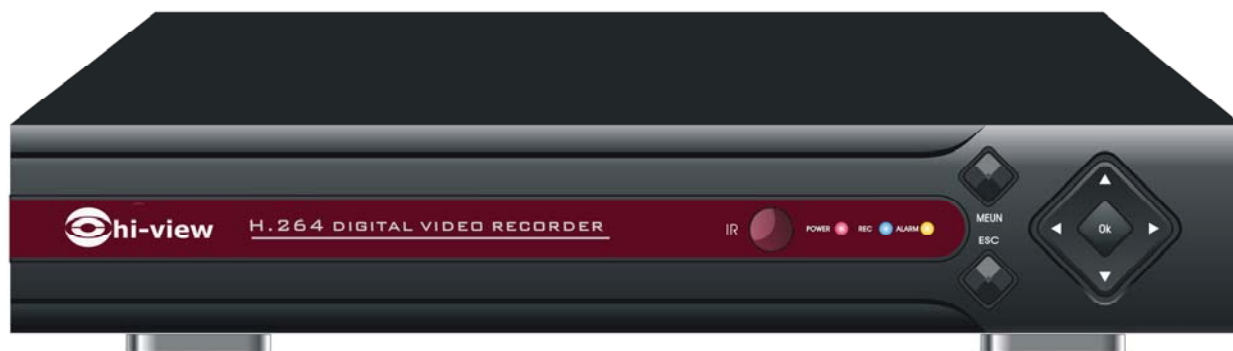

Welcome

Thank you for purchasing our DVR!

This manual is designed to be a reference tool for the installation and operation of your system.

Here you can find information about this series DVR features and functions, as well as a detailed menu tree.

Before installation and operation please read the following safeguards and warnings carefully!

Important Safeguards and Warnings

Do not place heavy objects on the DVR.

Do not let any solid or liquid fall into or infiltrate the DVR.

Please brush printed circuit boards, connectors, fans, machine box and so on regularly. Before the dust cleaning please switch off the power supply and unplug it.

Do not disassemble or repair the DVR by yourself. Do not replace the components by yourself.

Environment

Please place and use the DVR between 0°C and 40°C. Avoid direct sunlight. Stay away from heat source.

Do not install the DVR in damp environment.

Do not use the DVR in smoky or dusty environment.

Avoid collision or strong fall.

Please insure the DVR level installation in a stable workplace.

Please install in ventilated place. Keep the vent clean.

Use within the rating input and output scope.

Directory

1 Production Introduction	5
1.1 Product overview	5
1.2 Main functions.....	5
2 Open-package check and cable connections.....	7
2.1 Open-package check	7
2.2 Hard disk installation.....	7
2.3 Front panel.....	8
2.4 Rear panel	8
2.5 Audio and video input and output connections.....	9
2.5.1 Video input connections.....	9
2.5.2 Video output connections and options	9
2.5.3 Audio signal input.....	10
2.5.4 Audio signal output	10
2.6 Speed dome connections.....	10
3 Basic operation	11

3.1 Turn on.....	11
3.2 Turn off.....	11
3.3 System Login	12
3.4 Preview	12
3.5 Desktop shortcut menu	13
3.5.1 Main menu	13
3.5.2 Playback	14
3.5.3 Record Mode	17
3.5.5 PTZ control	17
3.5.6 Color setting.....	25
3.5.7 Output adjust	25
3.5.8 Logout.....	26
3.5.9 Window switch	27
4 Main menu	28
4.1 Main menu navigation.....	28
4.2 Record	26
4.2.1 Record Config.....	26
4.2.3 Playback	28
4.2.4 Backup.....	28
4.3 Alarm.....	32
4.3.1 Motion Detect.....	32
4.3.2 Video Blind.....	34
4.3.3 Video Loss	35
4.3.6 Abnormal.....	36
4.4 System.....	34
4.4.1 General	34
4.4.2 Encode	35
4.4.3 Network.....	37
4.4.4 NetSevice	37
4.4.5 GUI Display.....	43
4.4.6 PTZ.....	45
4.4.8 Tour.....	45
4.5 Advanced	46
4.5.1 HDD Manage	46
4.5.2 Account.....	47
4.5.3 Online user	50
4.5.4 Output adjust	50
4.5.5 Auto maintain	51
4.5.6 Restore	53
4.5.7 Upgrade.....	52
4.5.8 Device Info.....	52
4.6 Info.....	54
4.6.1 HDD info	54
4.6.2 BPS	55
4.6.3 Log.....	56
4.6.4 Version.....	56

4.7 Shut down system.....	57
5 FAQ and maintenance	58
5.1 FAQ.....	58
5.2 Maintenance	63
Appendix 1.Remote controller operation.....	64
Appendix 2.Mouse operation	65
Appendix 3.Hard disk capability calculation	66
Appendix 4.Technique parameters.....	67

1 Production Introduction

1.1 Product overview

The series DVR is designed specially for security and defence field which is an outstanding digital surveillance product. It introduces embedded LINUX operating system which is more stable. It introduces standard H.264mp video compressed format and G.711A audio compressed format which insures the high quality image, low error coding ratio and single frame playing. It introduces TCP/IP network technology which achieves the strong network communication ability and telecommunication ability.

The series DVR can be used individually or online applied as a part of a safety surveillance network. With the professional network video surveillance software it achieves the strong network communication ability and telecommunication ability.

The series DVR can be applied in the bank, telecom, electric power system, judicial system, transportation, intelligent housing, factory, storehouse, water conservancy and so on.

1.2 Main functions

Real-time surveillance

analog interface and VGA interface (VGA interface is equipped selectively)

surveillance function through monitor or display

Storage

non-working hard disk dormancy processing which is convenient to radiate heat, reduce power and extend the life-span

special storage format which insures the data safety

Compression

real-time compression by individual hard disk which insures the audio and video signal stable synchronization

Backup

through SATA interface and USB interface such as USB equipment, removable hard disk and so on

through net download the files in the hard disk

Playback

individual real-time video recording as well as searching, playback, network surveillance, recording check, downloading and so on

multi-playback mode

zoom at arbitrary region

Net operating

through net tele-surveillance in the real time

tele-PTZ control

tele-recording check and real-time playback

Alarm linkage

multi-route relay alarm output which is convenient for the alarm linkage and light control at the spot

protecting circuits at the alarm input and output interface which protects the main machine from damage

Communication interface

RS485 interface which fulfills the alarm input and PTZ control

standard ethernet network interface which fulfills the telecommuting function

Intelligent operating

mouse action function

fast copy and paste operating for the same setting

2 Open-package check and cable connections

2.1 Open-package check

When you receive the DVR, please check first .

First, please check whether there is any visible damage to the package appearance. The protective materials used for the package of the DVR can protect most accidental clashes during transportation.

Then, please open the box and get rid off the plastic protective materials. Check whether there is any visible damage to the DVR appearance.

At last, please open the machine crust and check the data wire in the front panel, power wire, the connection between the fan power and the main board.

Front panel and rear panel

- ◆ The key function specification in the front panel and the interface specification in the rear panel are in the specification.
- ◆ Please check the product type in the front panel whether is accordant with the product type you order.

The label in the rear panel is very important for the after service. Please protect it carefully. When you contact us for after service, please provide the product type and serial number in the label.

2.2 Hard disk installation

For the first use, please install the hard disk.



disassemble the screw



disassemble the cover



fix the screw of hard disk



□ connect SATA power wire



□ connect SATA data wire



□ the right connection



□ cover the machine



□ fix the cover



⑨ Installation finished

2.3 Front panel

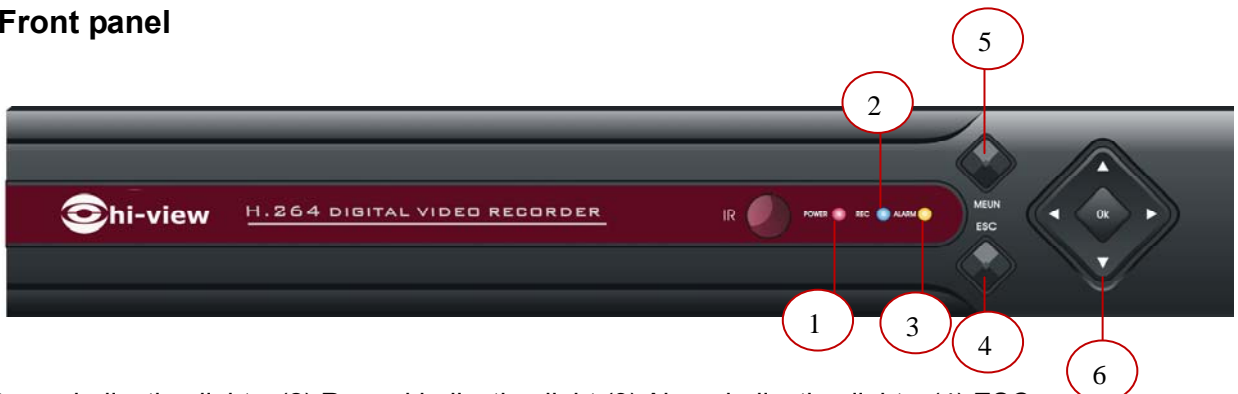

(1) Power indication light (2) Record indication light (3) Alarm indication light (4) ESC

(5) Menu

(6) Direction and OK

2.4 Rear panel

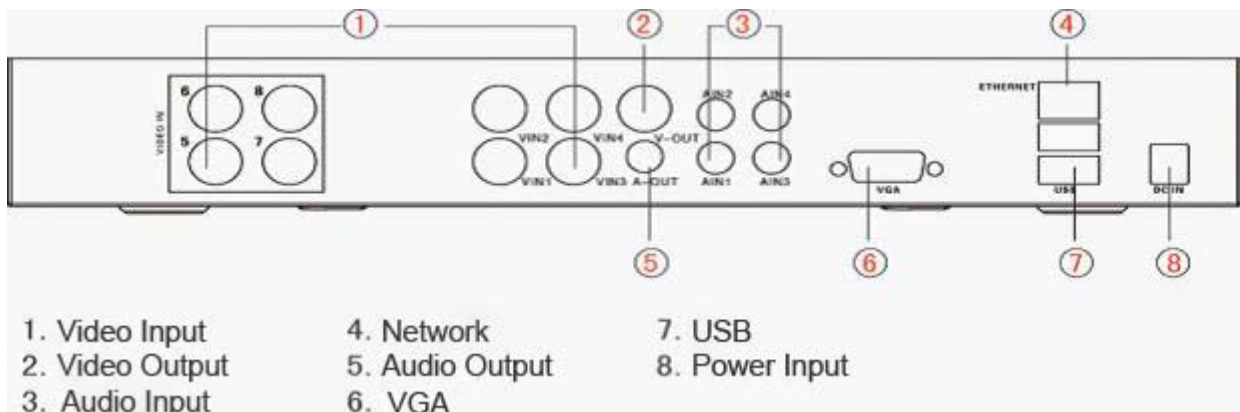

1. Video Input

2. Video Output

3. Audio Input

4. Network

5. Audio Output

6. VGA

7. USB

8. Power Input

2.5 Audio and video input and output connections

2.5.1 Video input connections

The video input port is BNC connector plug. The demand of input signal is PAL/NTSC BNC(1.0V_{P-P},75Ω).

The video signal must be accorded with the state standard which has the high signal to noise ratio, low aberration and low interference. The image must be clear and has natural color in the appropriate brightness.

Insure the vidicon signal stable and credible

The vidicon should be installed in the appropriate location where is away from backlighting and low illumination or adopts the better backlighting and low illumination compensation.

The ground and power supply of the vidicon and the DVR should be shared and stable.

Insure the transmission line stable and credible

The video transmission line should adopt high quality coaxial pair which is chosen by the transmission distance. If the transmission distance is too far, it should adopt shielded twisted pair, video compensation equipment and transmit by fiber to insure the signal quality.

The video signal line should be away from the electro magnetic Interference and other equipments signal lines. The high voltage current should be avoided especially.

Insure the connection stable and credible

The signal and shield lines should be firm and connected credible which avoid false and joint welding and oxidation.

2.5.2 Video output connections and options

The video output is divided into PAL/NTSC BNC(1.0V_{P-P},75Ω) and VGA output(selective configuration).

When replace the monitor by the computer display, there are some issues to notice.

- 1、 Do not stay in the turn-on state for a long time.
- 2、 Keep the computer display normal working by demagnetizing regularly.
- 3、 Stay away from the electro magnetic Interference.

TV is not a credible replacement as a video output. It demands reducing the use time and control the

power supply and the interference introduced by the nearby equipments strictly. The creepage of low quality TV can lead to the damage of other equipments.

2.5.3 Audio signal input

Audio port is BNC connection.

The input impedance is high so the tone arm must be active.

The audio signal line should be firm and away from the electro magnetic Interference and connected credible which avoid false and joint welding and oxidation. The high voltage current should be avoided especially.

2.5.4 Audio signal output

Commonly the output parameter of DVR audio signal is greater than 200mv 1KΩ(BNC) which can connect the low impedance earphone and active sound box or other audio output equipments through power amplifier. If the sound box and the tone arm can not be isolated, howling phenomena is often existed. There are some methods to deal with the above phenomena.

- 1、 Adopt better directional tone arm.
- 2、 Adjust the sound box volume to be under the threshold that produces the howling phenomena.
- 3、 Use fitment materials that absorb the sound to reduce reflection of the sound.
- 4、 Adjust the layout of the sound box and the tone arm.

2.6 Speed dome connections

- 1、 Connect the 485 lines of the speed dome with the DVR 485 interface.

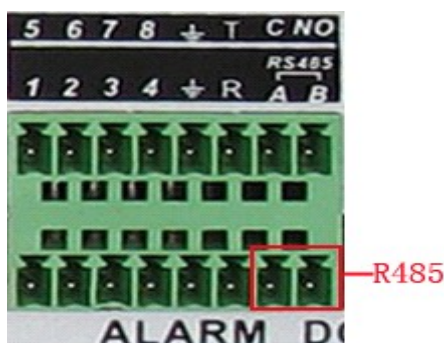

- 2、 Connect the video line with the DVR video input.
- 3、 Electrify the speed dome.

3 Basic operation

Note: The button in gray display indicates nonsupport.

3.1 Turn on

Plug the power supply and turn on the power supply switch. Power supply indicator light shining indicates turning on the video recorder. After the startup you will hear a beep. The default setting of video output is multiple-window output mode. If the startup time is within the video setting time, the timing video recording function will start up automatically. Then the video indicator light of corresponding channel is shining and the DVR is working normally.

Note:1. Make sure that the input voltage corresponds with the switch of the DVR power supply.

2. Power supply demands: 220V±10% /50Hz.

Suggest using the UPS to protect the power supply under allowable conditions.

3.2 Turn off

There are two methods to turn off the DVR. Entering [main menu] and choosing [turn off] in the [turn off the system] option is called soft switch. Pressing the power supply switch is called hard switch.

Illumination:

1、 Auto resume after power failure

If the DVR is shut down abnormally, it can automatically backup video and resume previous working status after power failure.

2、 Replace the hard disk

Before replacing the hard disk, the power supply switch in the real panel must be turned off.

3、 Replace the battery

Before replacing the battery, the setting information must be saved and the power supply switch in the real panel must be turned off. The DVR uses button battery. The system time must be checked regularly. If the time is not correct you must replace the battery, we recommend replacing the battery every year and using the same battery type.

Note: The setting information must be saved before replacing the battery otherwise information

will lose.

3.3 System Login

When the DVR boots up, the user must login and the system provides the corresponding functions with the user purview. There are three user settings. The names are **admin**, **guest** and **default** and these names have no password. **Admin** is the super user purview; guest and **default**'s permissions are preview and video playback. User **admin** and **guest**'s password can be revised, while their permissions can't be revised; user **default** is the default login user whose permission can be revised but not its password.



Picture 3.1 System Login

Password protection: If the password is continuous wrong three times, the alarm will start. If the password is continuous wrong five times, the account will be locked. (Through reboot or after half an hour, the account will be unlocked automatically).

For your system security, please modify your password after first login.

3.4 Preview

You can right click mouse to choose the switch between the windows.

The system date, time and channel name are shown in each viewing window. The surveillance video and the alarm status are shown in each window.





1		Recording status	3		Video loss
2		Motion detect	4		Camera lock

Table 3.1 Preview icon

3.5 Desktop shortcut menu

In preview mode you can right click mouse to get a desktop shortcut menu. The menu includes: main menu,record mode,playback,PTZ control,High Speed PTZ,Alarm Output,color Setting,Output adjust,Logout,view1/4/8/9/16 screens.

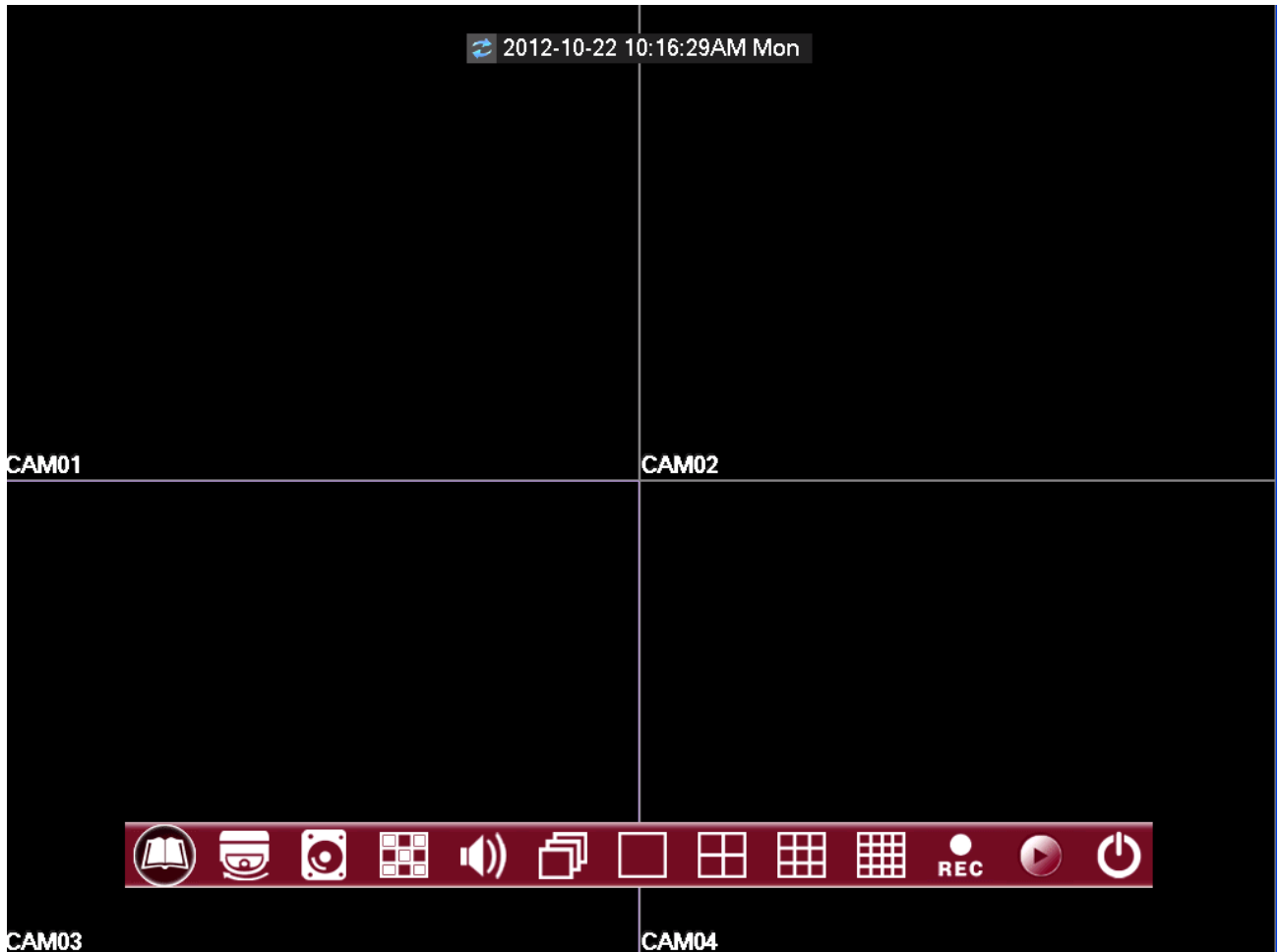

Picture 3.2 Shortcut Menu

3.5.1 Main menu

When you login, the system main menu is shown as below.



Picture3.3 Main Menu

3.5.2 Playback

There are two methods for you to play the video files in the hard disk.

- 1、 In the desktop shortcut menu.
- 2、 Main menu>Record->Playback

Note: The hard disk that saves the video files must be set as read-write or read-only state.(4.5.1)

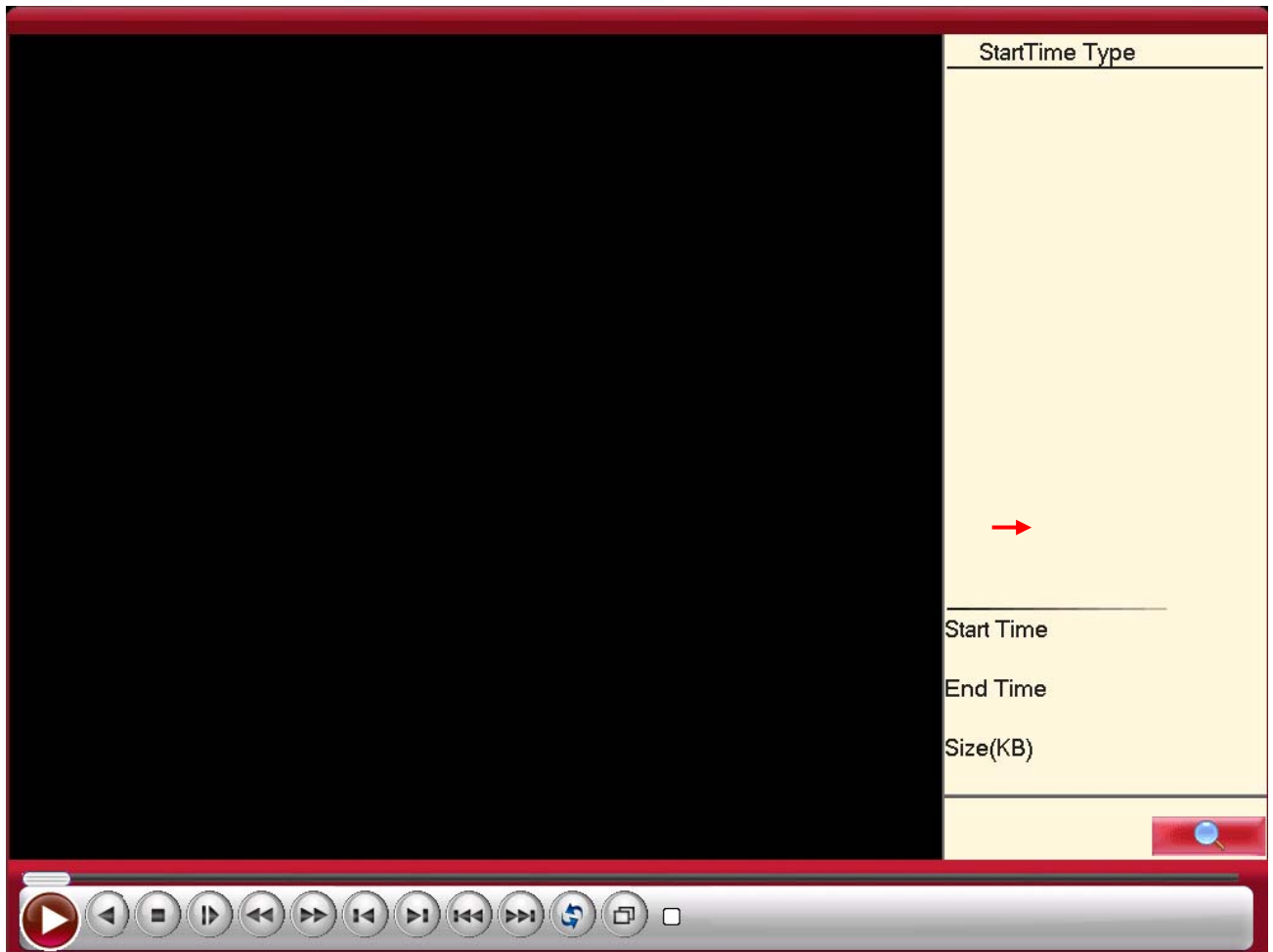

Picture 3.4 video playback

- | | | |
|-----------------|---------------------|---------------------|
| 1. listed files | 2. file information | 3. file searching |
| 4. file backup | 5. Operation hint | 6. Playback control |

【Listed files】 Look up the listed files that accord with the searching criteria.

【File information】 Look up the found file information.

【File backup】 Backup the chosen file. Click the button and operate as followed.

Note: The storage must be installed before the file backup. If the backup is terminated, the already backup can playback individually.

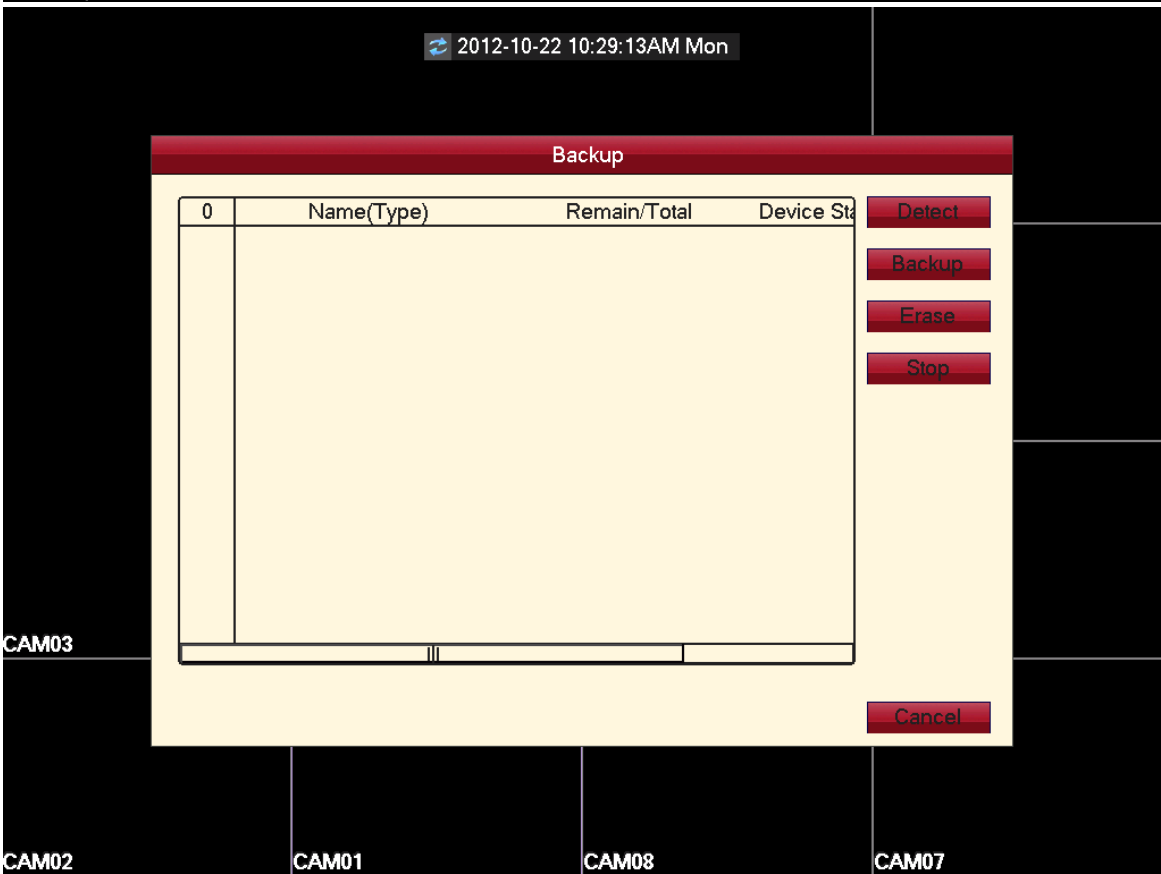
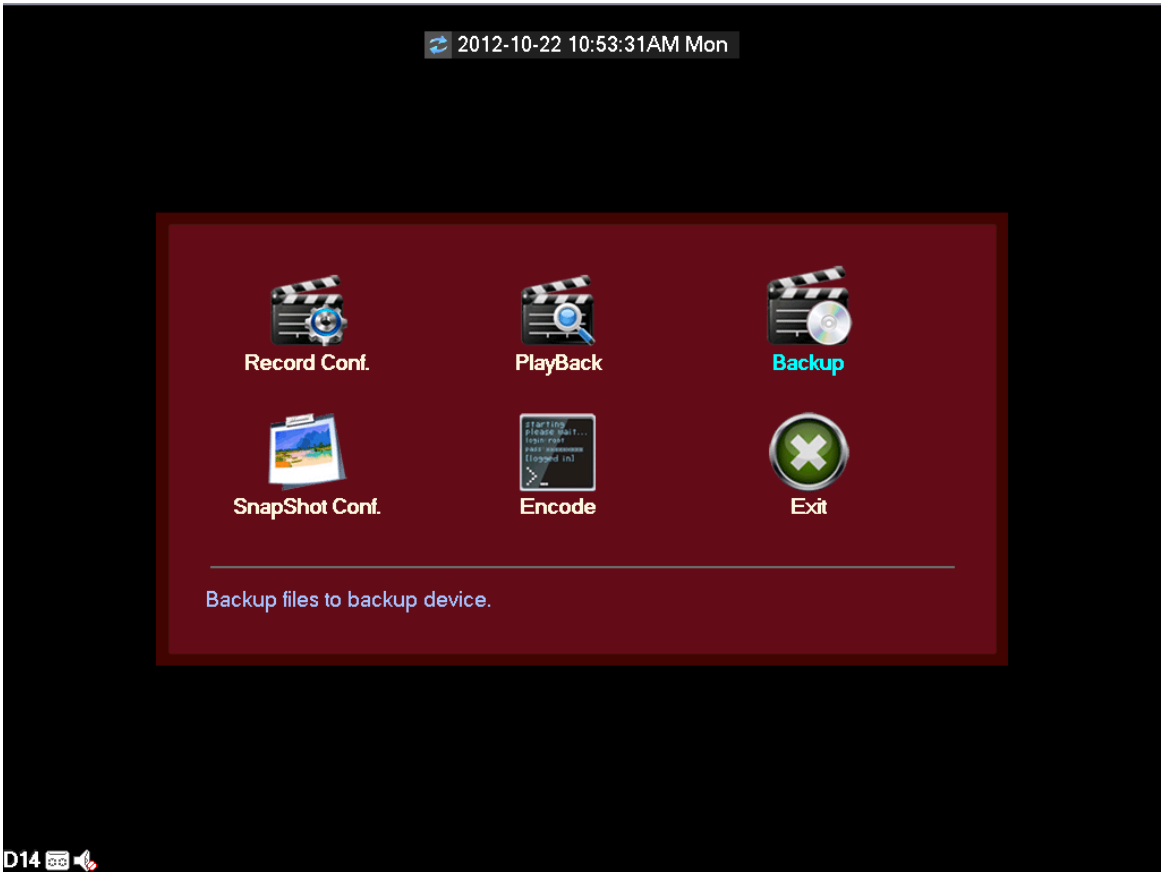

Picture 3.5 detect the storage

Detect: Detect the storage connected with the DVR such as hard disk or universal disk.

Erase: Choose the file to delete and click erasure to delete the file.

Stop: Stop the backup.

Backup: Click backup button and the dialog box is popped up. You can choose the backup file according to the type, channel and time.

Remove: Clear the file information.

Add: Show the file information satisfying the set file attributes.

Start/Pause: Click the play button to start the backup and click the pause button to stop the backup.

Cancel: During backup you can exit the page layout to carry out other functions.

【File searching】 Search the file according to the searching parameter.

File type: Set the searching file type.

Channel: Set the searching channel.

Start Time: Set the searching time scan.

【Playback control】 Refer to the following sheet for more information.













Button	Function	Button	Function
	Play/pause		Backward
	Stop		Slow play
	Fast play		Previous frame
	Next frame		Previous file
	Next file		Circulation
	Full screen		

Table 3.2 Playback control key

Note: Frame by frame playback is only performed in the pause playback state.

【Operation hint】 Display the function of the cursor place.

Special functions:

Accurate playback: Input time (h/m/s) in the time column and then click play  button. The system can operate accurate playback according to the searching time.

Local zoom: When the system is in single-window full-screen playback mode, you can drag your

mouse in the screen to select a section and then left click mouse to realize local zoom. You can right click mouse to exit.

3.5.3 Record Mode

Please check current channel status: “○” means it is not in recording status, “●” means it is in recording status.

You can use desktop shortcut menu or click [main menu]> [recording function]> [recording set] to enter the recording control interface.

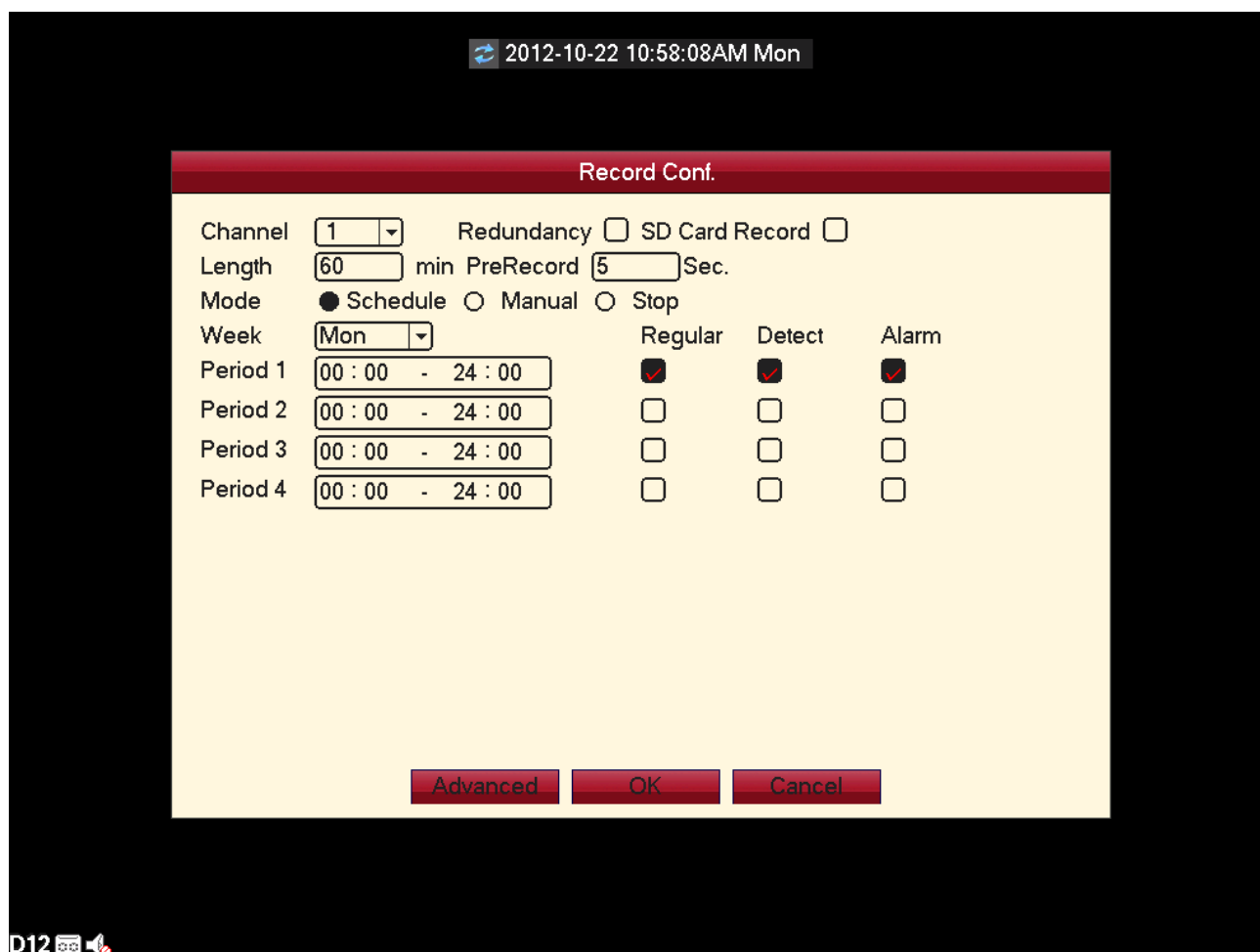

Picture 3.8 Record Mode

【Schedule】 Record according to the configuration.

【Manual】 Click the all button and the according channel is recording no matter the channel in any state.

【Stop】 Click the stop button and the according channel stops recording no matter the channel in any state.

3.5.4 PTZ control

Operation interface is as followed. The functions include: PTZ direction control, step, zoom, focus, iris, setup operation, patrol between spots, trail patrol, boundary scan, assistant switch, light switch, level rotation and so on.

Note1. Decoder A(B)line connects with DVR A(B)line. The connection is right.



2. Click [main menu] >[system configuration] >[PTZ setup] to set the PTZ parameters.

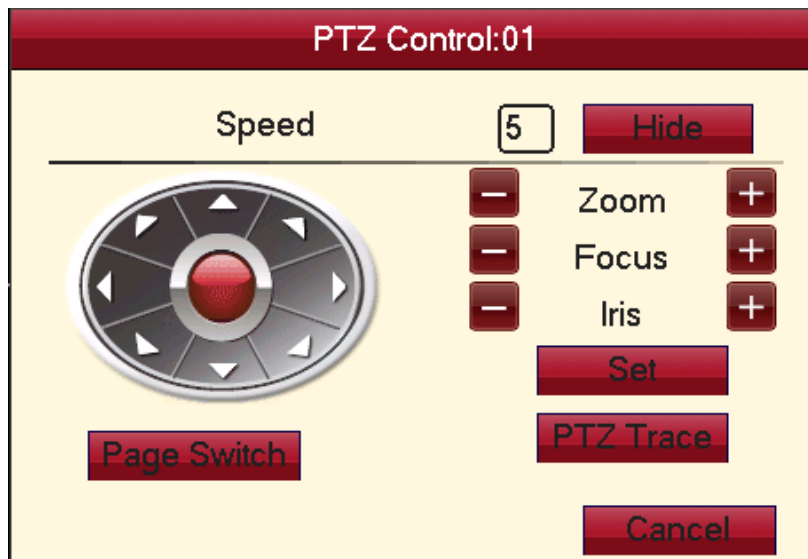

3. The PTZ functions are decided by the PTZ protocols.





Picture 3.10 PTZ setup

【Speed】 Set the PTZ rotation range. Default range: 1 ~ 8.

【Zoom】 Click  /  button to adjust the zoom multiple of the camera.

【Focus】 Click  /  button to adjust the focus of the camera .

【Iris】 Click  /  button to adjust the iris of the camera.

【Direction control】 Control the PTZ rotation. 8 directions control is supportive.(4 directions in Front panel is supportive)

【High speed PTZ】 Full-screen show channel image. Left press mouse and control PTZ to rotate orientation. Left press mouse and then rotate the mouse to adjust the zoom multiple of the camera.

【Set】 Enter the function operation menu.

【Page switch】 Switch between different pages.

Special functions:

1、Preset

Set a location for the preset, calls the preset points, PTZ automatically turns to the setting position

1) Preset option

Set a location for the preset, procedure is as follows:

Step1: in Picture 3.10, click the Direction button will turn into preset position , click the Settings button to enter Picture 3.11.

Step 2: click the Preset button , then write the preset points in the input blank,

Step 3: click Settings button, return the Picture 3.10 Complete setup, that is the preset points and preset position corresponds.

Clear Preset: Input preset points, click Remove button, remove the preset.

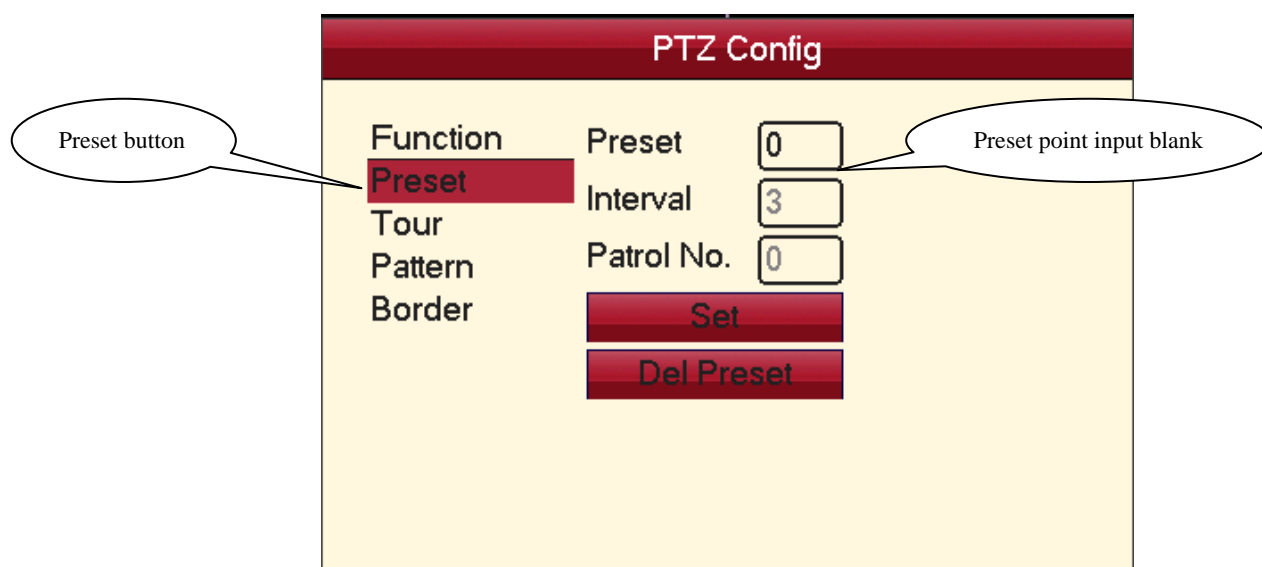

Picture 3.11 Preset Settings

2) Preset Point Calls

In Picture 3.10, click Page Shift button, enter PTZ control interface as shown in Picture 3.12. In the input blank, write the preset points, then click Preset button, PTZ turn to the corresponding preset point.

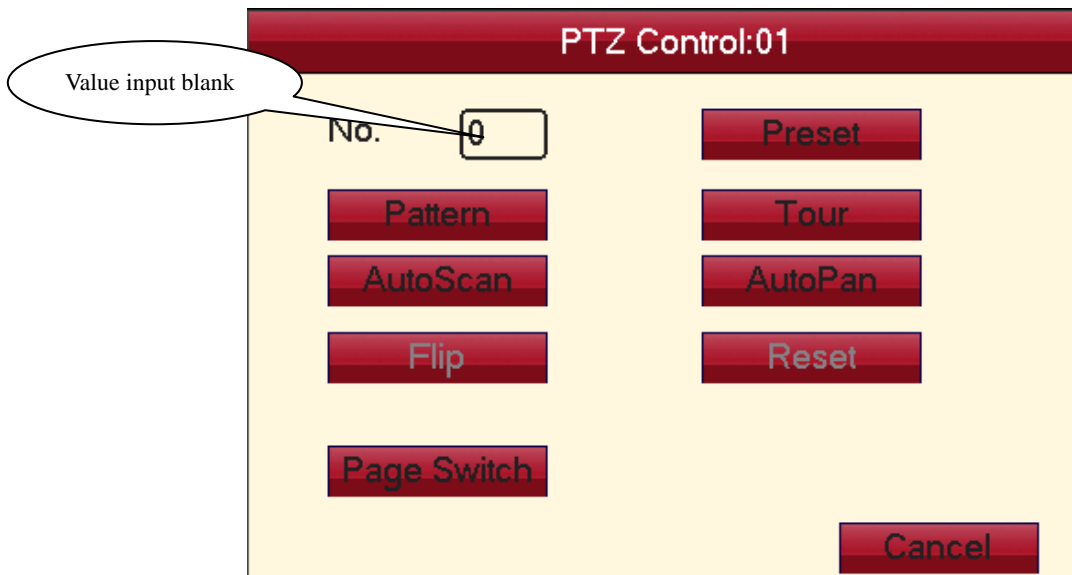

Picture 3.12 PTZ Control

2、Cruise between Points

Multiple preset points connected cruise lines, call cruise between points, the PTZ run around on the line

1) Cruise Between Points Settings

Cruise lines is connected by multiple preset points, setting procedure is as follows:

Step1: In Picture 3.10, the Direction key will turn PTZ to designated location , click Settings button to enter Picture 3.13,

Step 2: click Cruise buttons, the write proper value into the Cruise Line and Preset Points blank, then click Add Preset Points button, complete setting (also can add and delete cruise line which has been set up)

Step 3: repeat step1 and step2 , until set out all the preset designated cruise lines.

Remove Preset: Please input preset value in the blank, click Remove Preset button, then remove the preset points.

Remove Cruise Line: Input the number of cruise line, click Remove Cruise Lines button, then remove the cruise lines set.

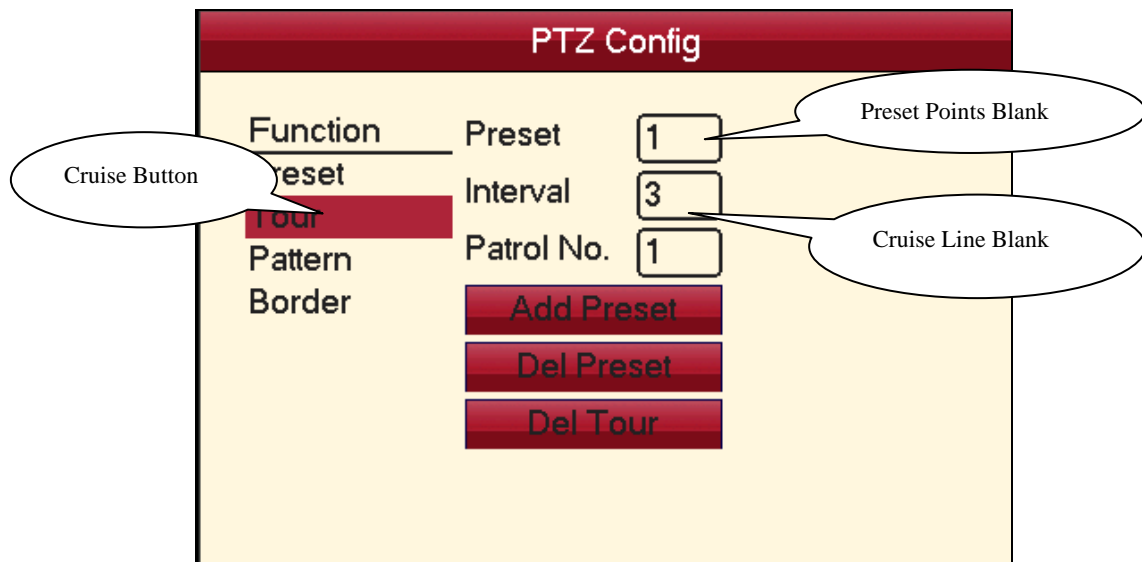

Picture 3.13 Cruise Between Points Settings

2) The Calls of Cruise between Points

In Picture 3.10, click Page Shift button, enter PTZ control menu as shown in Picture 3.12. Please input the number of cruise in the value blank, then click Cruise between Points button, PTZ begins to work on the cruise line. Click Stop button to stop cruise.

3、 Scan

PTZ also can work on the preset scan line repeatedly.

1) Scan setup

Step1: In Picture 3.10, click Setup button , enter Picture 3.14;

Step2: Click Scan button, the input proper value in the scan value blank;

Step3: Click Start button, enter Picture3.10, here you can set the following items: Zoom、 Focus、 Aperture、 Direction and so on. Click Setup button to go back Picture 3.14;

Step4: Click End button to complete setup。 Click the right button of the mouse to exit.

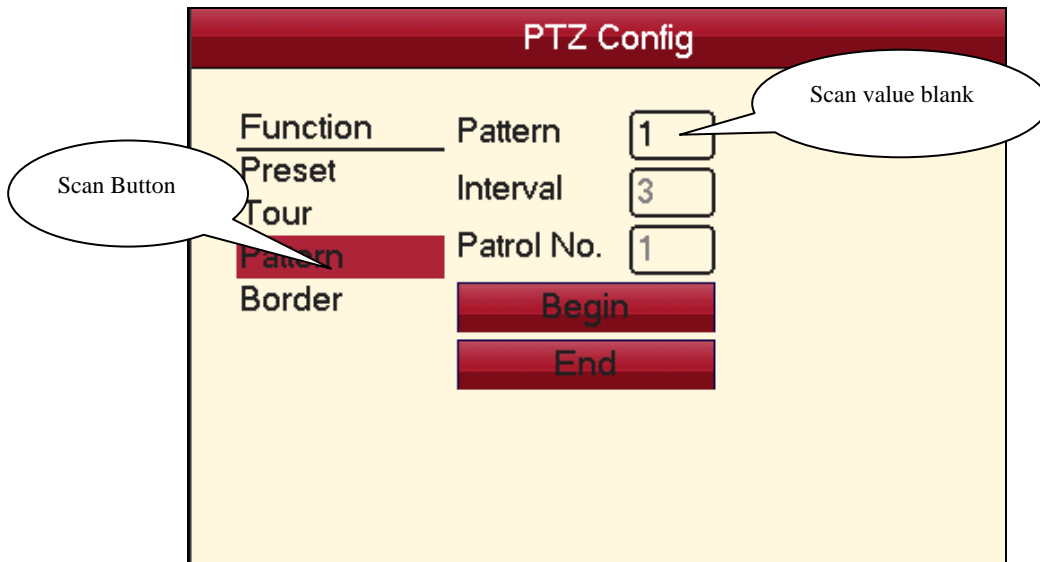

Picture 3.14 Scan Setup

2) Scan Calls

In Picture 3.10, click Page Shift button, then enter PTZ control menu as shown in Picture 3.12. Please input the number of scan in the value blank , then click Scan button. PTZ begins to work on the scan line . Click Stop button to stop.

4、 Boundary Scan

1) Boundary Scan setup

Step1: In Picture 3.10, click Direction button to turn the PTZ to preset direction, then click Setup button enter Picture 3.15, select the left boundary, return to Picture 3.10;

Step2: Please click direction arrows to adjust PTZ direction, click Setup button enter Picture3.15, then select the right boundary ,return to Picture 3.10;

Step3: Complete setup, that is the position of left and right boundary

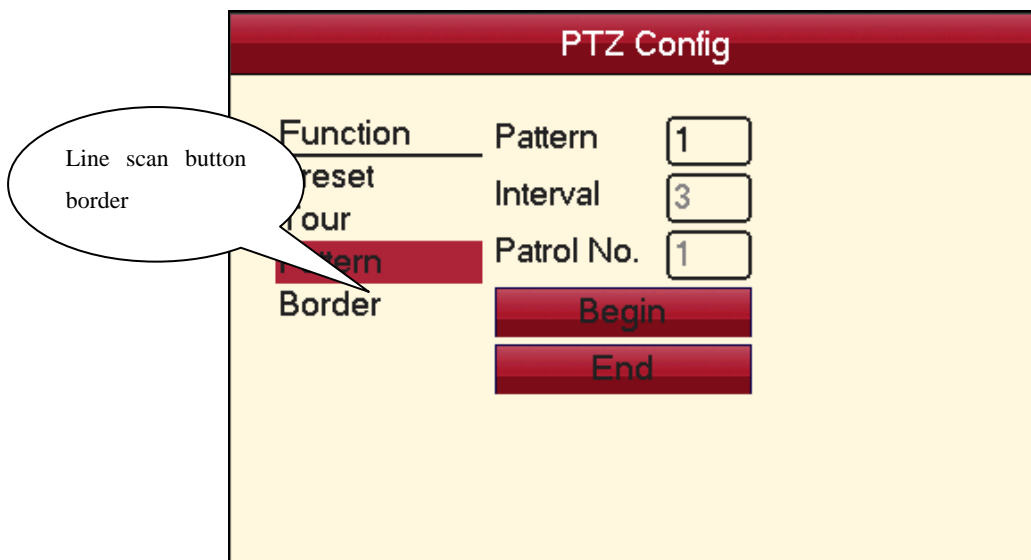

Picture 3.15 Boundary Scan Setup

2) Boundary Scan Calls

In Picture 3.10, click Page Shift button, then enter PTZ control menu as shown in Picture 3.12. Please input the number of scan in the value blank , then click Scan button, PTZ begins to work on the scan line . Click Stop button to stop.

5、 Horizontal Rotating

Click Horizontally Rotating button, PTZ begins to rotate horizontally (relative to the original position of the camera). Click the Stop button to stop.

6、 Rotate

Click on horizontal Rotating button, PTZ turn around.

7、 Reset

PTZ restart, all the data clears to 0.。

8、 Page Shift

In Picture 3.12, click Page Shift button into Picture3.16, setting auxiliary function. Auxiliary number corresponding to auxiliary switch on the decoder.

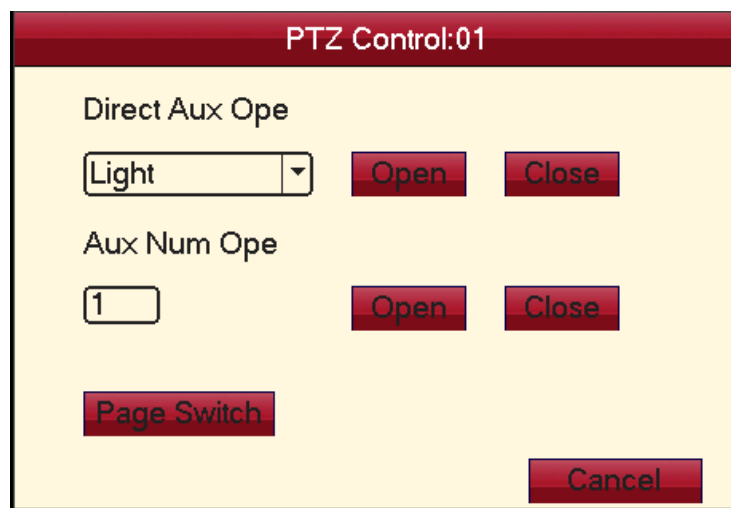

Picture 3.16 Auxiliary Function Control

【Intuitive Auxiliary Operation】 choose auxiliary equipment, select Open or Close button, switch control;

【Auxiliary Number】 The operation of corresponding auxiliary switch according to PTZ agreement;

【Page Shift】In Picture 3.16, click Page Shift button enter the Picture 3.17 PTZ Main Menu , the

menu itself can be control by the menu control buttons

3.5.5 Color setting

Set the selective image parameters (current channel for single window display and cursor place for multi-window display). You can use the desktop shortcut menu and enter the interface. The image parameters include: tonality, brightness, contrast, saturation. You can set different parameters at different time sections.

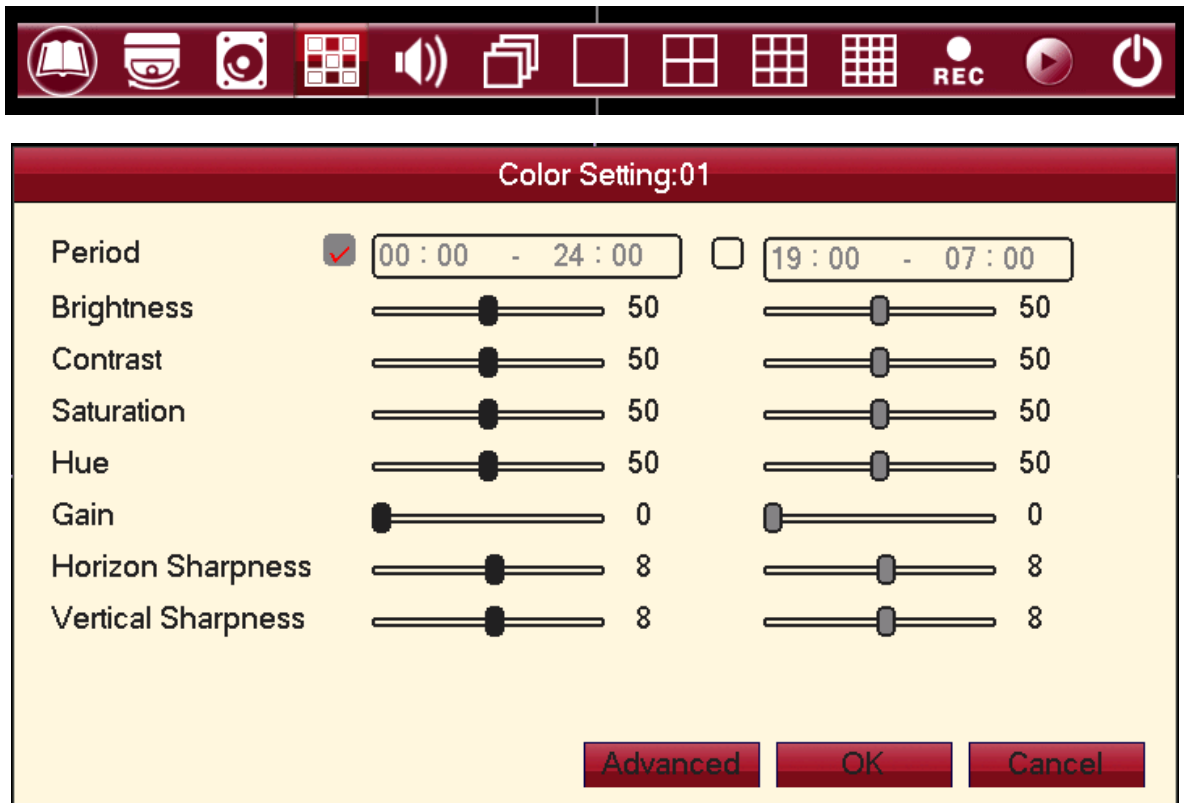

Picture 3.18 Color Setting

3.5.6 Output Adjust

Adjust TV output area parameters. You can use the desktop shortcut menu or enter [main menu]> [management tools]> [Output adjust].

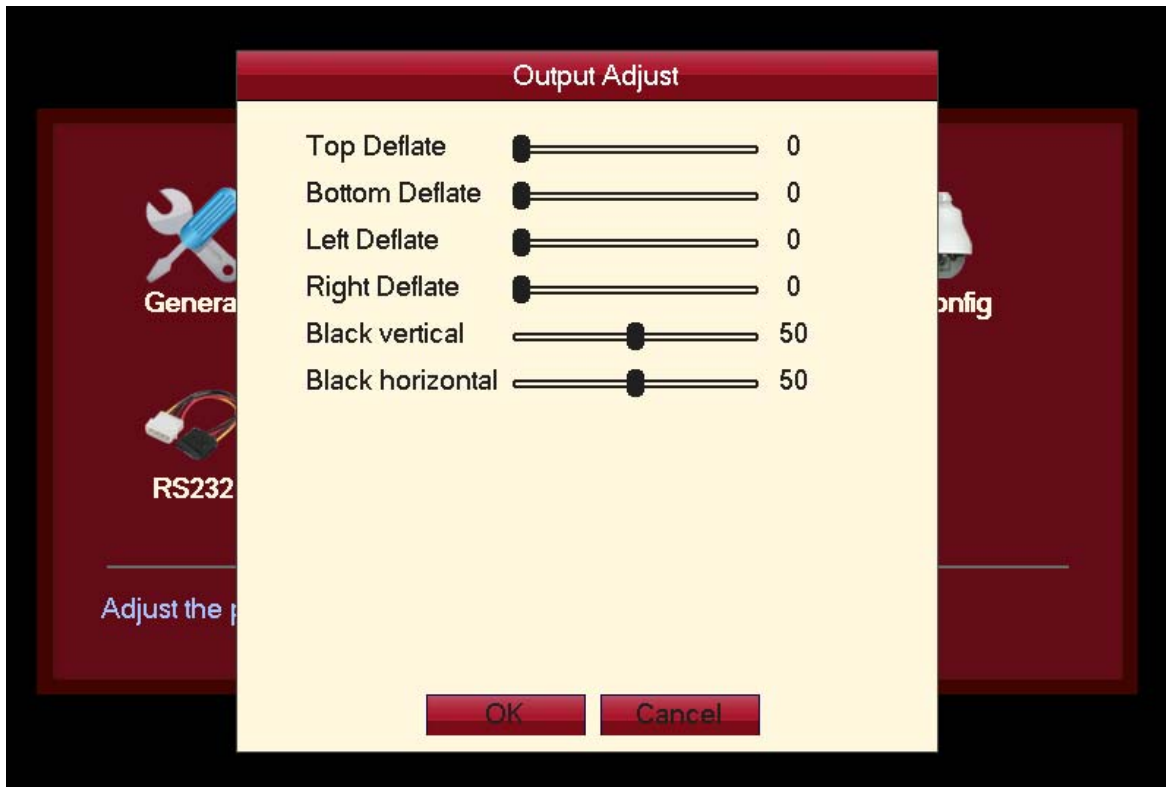

Picture 3.19 Output Adjust

3.5.7 Logout

Logout, shut down the system or reboot up. You can use the desktop shortcut menu or enter [main menu].

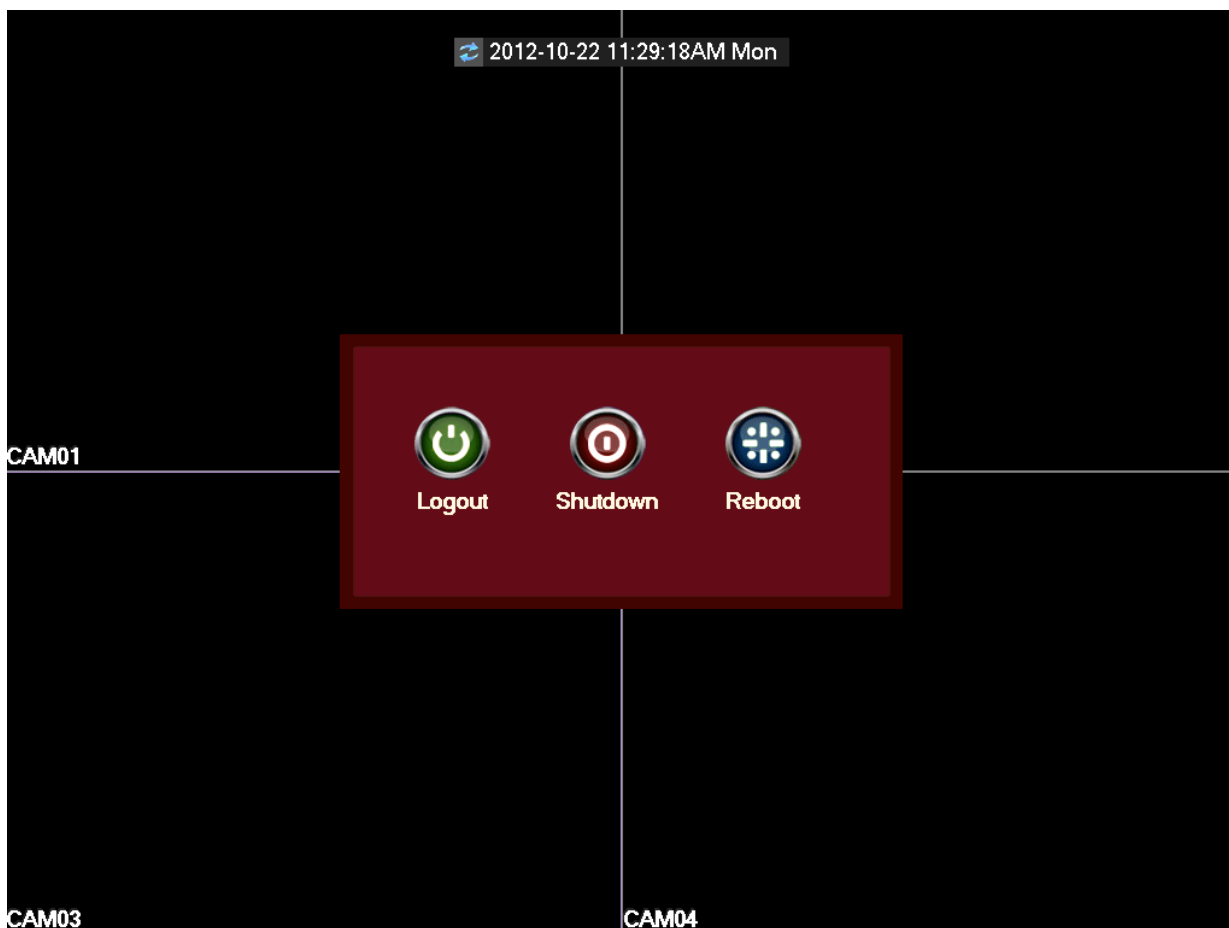

Picture 3.20 Logout/Reboot the system

【logout】 Quit the menu. Offer password next entrance.

【reboot】 Quit the system. Reboot up the system..

3.5.9 Window switch

Preview in single window/four windows/eight windows/nine windows/sixteen windows according to your choice.

4 Main menu

4.1 Main menu navigation



4.2 Record

4.2.1 Record Config

Set the recording parameters in the surveillance channel. The system is set 24 hours consecutive recording in the first startup. You can enter [main menu]> [recording function]> [recording setup] to set.

Note: There is at least one read-write hard disk. (refer to chapter 4.5.1)

Record Conf.

Channel Redundancy SD Card Record

Length min PreRecord Sec.

Mode Schedule Manual Stop

Week Regular Detect Alarm

Period	Time Range	Regular	Detect	Alarm
Period 1	<input type="text" value="00 : 00 - 24 : 00"/>	<input checked="" type="checkbox"/>	<input checked="" type="checkbox"/>	<input checked="" type="checkbox"/>
Period 2	<input type="text" value="00 : 00 - 24 : 00"/>	<input type="checkbox"/>	<input type="checkbox"/>	<input type="checkbox"/>
Period 3	<input type="text" value="00 : 00 - 24 : 00"/>	<input type="checkbox"/>	<input type="checkbox"/>	<input type="checkbox"/>
Period 4	<input type="text" value="00 : 00 - 24 : 00"/>	<input type="checkbox"/>	<input type="checkbox"/>	<input type="checkbox"/>

Picture 4.1 Record Config

【Channel】 Choose the corresponding channel number to set the channel. Choose the all option to set the entire channels.

【Redundancy】 Choose the redundancy function option to implement the file double backup function. Double backup is writing the video files in two hard disks. When you do the double backup, make sure that there are two hard disks installed. One is read-write disk and the other is redundant disk. (refer to 4.5.1)

【Length】 Set the time length of each video file. 60minutes is default value.

【PreRecord】 Record 1-30 seconds before the action. (time length is decided by the code stream)

【Record mode】 Set video state: schedule, manual or stop.

Schedule: Record according to the set video type (common, detection and alarm) and time section.

Manual: Click the button and the according channel is recording no matter the channel in any state.

Stop: Click the stop button and the according channel stops recording no matter the channel in any state.

【Period】 Set the time section of common recording, The recording will start only in the set range.

【Record type】 Set recording type: regular, detection or alarm.

Regular: Perform the regular recording in the set time section. The video file type is “R”.

Detect: Trigger the “motion detect”, “camera mask” or “video loss” signal. When above alarm is set as opening recording, the “detection recording” state is on. The video file type is “M”.

Alarm: Trigger the external alarm signal in the set time section. When above alarm is set as opening recording, the “detection recording” state is on. The video file type is “A”.

Note: Refer to chapter 4.3 to set corresponding alarm function.

4.2.2 Playback

Refer to chapter 3.5.2.

4.2.3 Backup

You can backup the video files to external storage through setup.

Note: The storage must be installed before the file backup. If the backup is terminated, the already backup can playback individually.

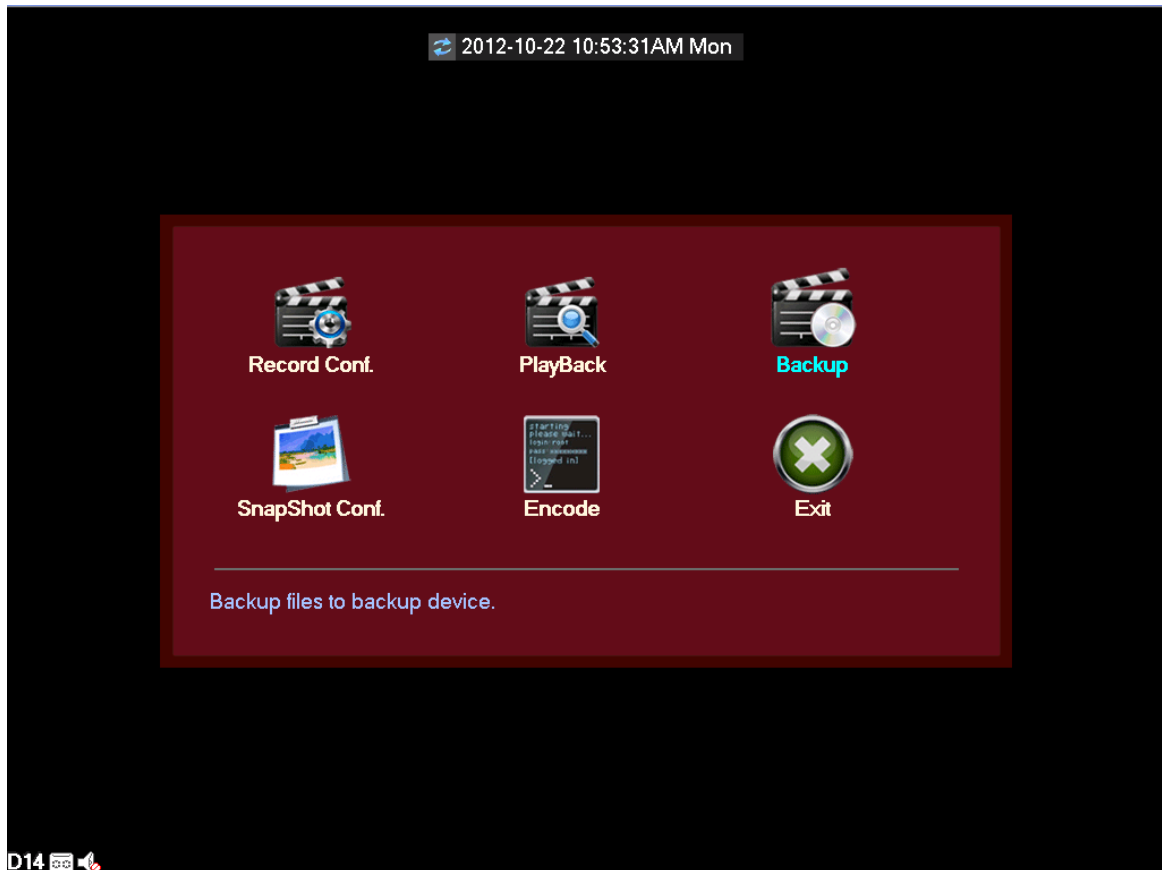

Picture 4.3 Backup

【Detect】 Detect the storage connected with the DVR such as hard disk or universal disk.

【Erase】 Choose the file to delete and click erasure to delete the file.

【Stop】 Stop the backup.

【Backup】 Click backup button and the dialog box is popped up. You can choose the backup file according to the type, channel and time.

Remove: Clear the file information.

Add: Show the file information satisfying the set file attributes.

Start/pause: Click the play button to start the backup and click the pause button to stop the backup.

Cancel: During backup you can exit the page layout to carry out other functions.

4.3 Alarm Function

Alarm functions include: motion detect, video blind, video loss, alarm input and alarm output.

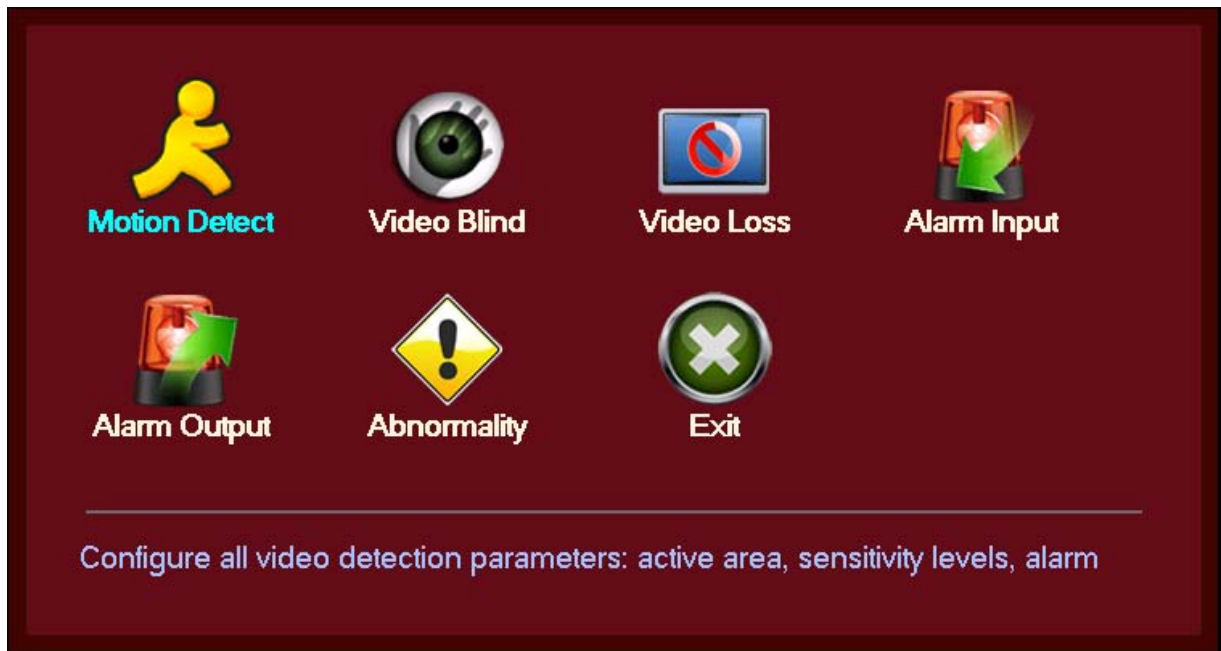

4.3.1 Motion Detect

When system detects the motion signal that reaches the set sensitivity, the motion detect alarm is on and the linkage function is turned on.

Picture 4.4 Motion Detect

【Channel】 Choose the set motion detect channel.

【Enable】 ■ means that the motion detect function is on.

【Sensitivity】 Choose in the six options according to the sensitivity.

【Region】 Click setup and enter the set area. The area is divided into PAL 8x8. Green block means the current cursor area. Yellow block means the dynamic detect defensive area. Black block means the unfenced area. You can set the area as followed, Drag the mouse and draw the area.

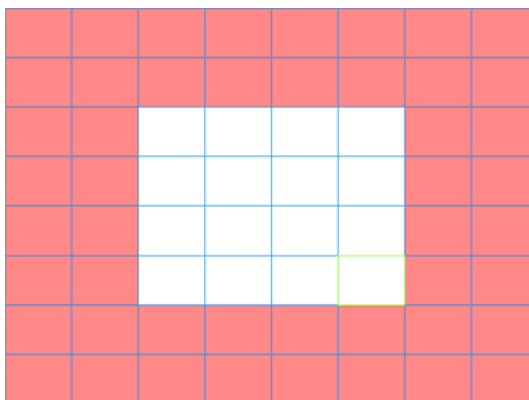

Picture 4.5 Region

【Period】 Trigger the motion detect signal in the set time section. You can set according to week or set uniformly. Each day is divided into four time sections. ■ means the set valid.

Picture 4.6 set the time section

【Interval】 Only one alarm signal is turned on even there are several motion detect signals in the set interval.

【Alarm output】 Start the external equipment of corresponding linkage alarm when the motion detect alarm is turned on.

【Delay】 Delay a few moments and stop when the alarm state is turned off. The range is 10~300 seconds.

【Record channel】 Choose the recording channel (multiple option supportive). Trigger the video signal when the alarm is turned on.

Note:Set in the [recording setup] and perform the linkage recording. Start detecting video files in the corresponding time section.

【Tour】 ■ means that the selective channel is single window alternate patrol preview. The interval is set in the [MainMenu]>[System] > [Tour].

【Snapshot】 Choose record channels,when alarm happens,system triggers related channels for snapshot signal.

Note:For Snapshot activation,pls go to set period,detect and alarm enable at MainMenu->Record->Record config,

【PTZ Activation】 Set the PTZ activation when the alarm is turned on.

Note:PTZ activation is set in the [shortcut menu] >[PTZ control]. Set the patrol between spots, trail patrol and so on.

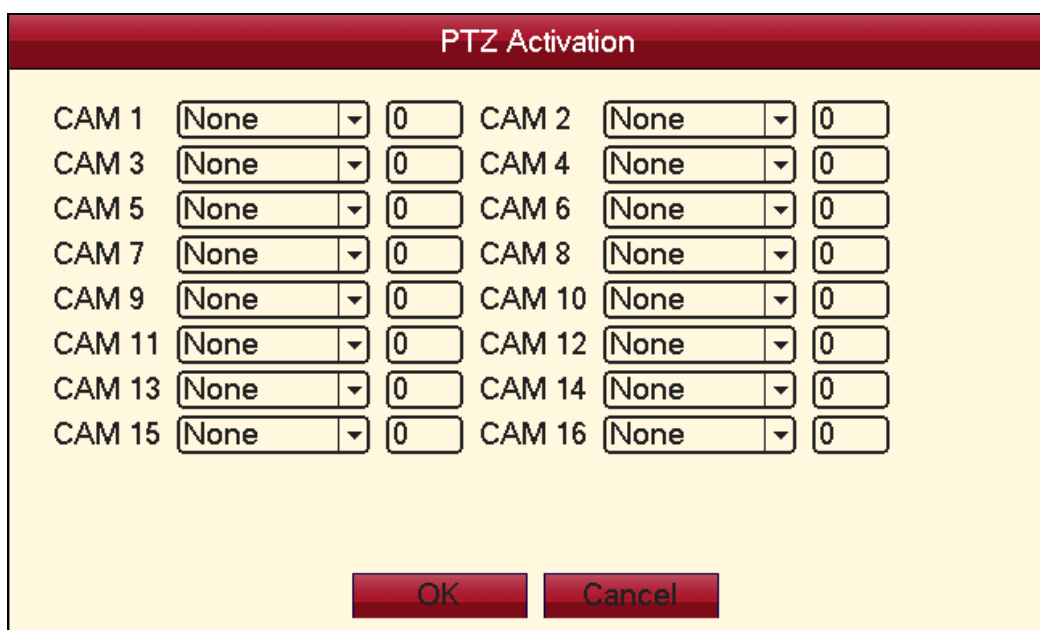

Picture 4.8 PTZ Activation

【Delay】 When alarm is over,recording will last some seconds(10~300sec),then stop.

【Show message】 Pop the alarm information dialog box in the local host computer screen.

【Send EMAIL】 ■ means sending an email to user when the alarm is turned on.

Note:Set in the [NetService] and send email.

4.3.2 Video Blind

When the video image is influenced by the environment such as bad brightness or reaching the set sensitivity parameter, the camera mask function is turned on and the linkage function is turned on.

Video Blind

Channel	<input type="text" value="1"/>		Enable	<input checked="" type="checkbox"/>
Sensitivity	<input type="text" value="Middle"/>			

Period	<input type="button" value="Set"/>			
Alarm Output	<input type="text" value="1"/> <input type="text" value="2"/>	Delay	<input type="text" value="10"/>	Sec.
Record Channel	<input type="text" value="1"/> <input type="text" value="2"/> <input type="text" value="3"/> <input type="text" value="4"/> <input type="text" value="5"/> <input type="text" value="6"/> <input type="text" value="7"/> <input type="text" value="8"/> <input type="text" value="9"/> <input type="text" value="10"/> <input type="text" value="11"/> <input type="text" value="12"/> <input type="text" value="13"/> <input type="text" value="14"/> <input type="text" value="15"/> <input type="text" value="16"/>			
Tour	<input type="text" value="1"/> <input type="text" value="2"/> <input type="text" value="3"/> <input type="text" value="4"/> <input type="text" value="5"/> <input type="text" value="6"/> <input type="text" value="7"/> <input type="text" value="8"/> <input type="text" value="9"/> <input type="text" value="10"/> <input type="text" value="11"/> <input type="text" value="12"/> <input type="text" value="13"/> <input type="text" value="14"/> <input type="text" value="15"/> <input type="text" value="16"/>			
Snapshot	<input type="text" value="1"/> <input type="text" value="2"/> <input type="text" value="3"/> <input type="text" value="4"/> <input type="text" value="5"/> <input type="text" value="6"/> <input type="text" value="7"/> <input type="text" value="8"/>			
PTZ Activation	<input type="button" value="Set"/>	Delay	<input type="text" value="10"/>	Sec.
Show Message	<input type="checkbox"/>	Send Email	<input type="checkbox"/>	
Buzzer	<input type="checkbox"/>	FTP upload	<input type="checkbox"/>	

Picture 4.9 Video Blind

Set method: refer to chapter 4.3.1. Motion detect

Note:"Advanced" button is the same as rightclick.

4.3.3 Video Loss

When the equipment can not obtain the channel video signal, the video loss alarm is turned on and the linkage function is turned on.

Channel: 1 Enable:

Period:

Alarm Output: 12 Delay: 10 Sec.

Record Channel: 1 2 3 4 5 6 7 8 9 10 11 12 13 14 15 16

Tour: 1 2 3 4 5 6 7 8 9 10 11 12 13 14 15 16

Snapshot: 1 2 3 4 5 6 7 8

PTZ Activation: Delay: 10 Sec.

Show Message: Send Email:

Buzzer: FTP upload:

Picture 4.10 Video loss

Set method: refer to chapter 4.3.1. Motion detect

Note:"Advanced" button is the same as rightclick.

4.3.4 Abnormal

Analysing and inspecting current software and hardware of the device: When some abnormal events happen, the device will make a relative answer such as show message and buzzer.

Event Type: No Disk Enable:

Show Message:

Buzzer:

Picture 4.12 Abnormal

- 【Event Type】 selecting abnormality you want to inspect
- 【Enable】 Select it to make sure abnormal function workable
- 【Show message】 Automatically alarm cue dialog box come out of the main screen
- 【Buzzer】 Device will have two long nosie “di di” while alarm is happening

4.4 System setup

Set the system parameters such as **General,Encode,NetWork,NetService,GUI display,PTZ config, RS232 and Tour setup.**

4.4.1 General

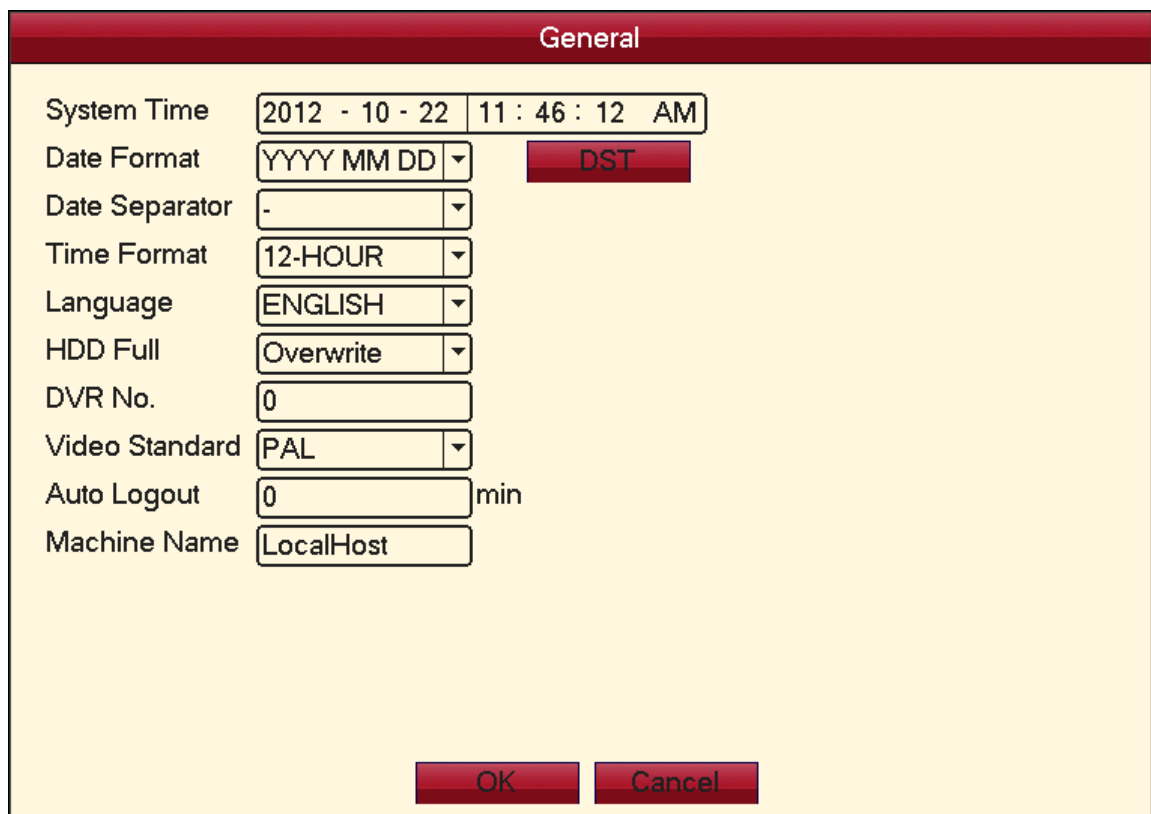

Picture 4.13 General setup

【System time】 Set the system data and time.

【Date format】 Choose the data format: YMD, MDY, DMY.

【Date Separator】 Choose list separator of the data format.

【Time Format】 Choose time format: 24-hour or 12-hour.

【Language】

Arabic,Czech,English,Finnish,Greek,Indonesian,Italian,,Japanese,Portuguese,Russian,Thai,T-Chinese,S-Chinese,

Turkish,Brazilian,Bulgarian,Farsi,French,German,Hebrew,Hungarian,Polish,Romanian,Spanish,Swedish,Vietnamese

【HDD full】 Choose stop record: Stop recording when the hard disk is full.

Choose overwrite: Cover the earliest recording files and continue recording when the hard disk is full.

【DVR No.】 Only when the address button in the remote controller and the corresponding DVR number is matched, the remote operation is valid.

【Video Standard】 PAL or NTSC.

【Auto Logout】 Set the latency time in 0-60. 0 means no latency time.

【DST】 Choose the summer time option and pop the dialog box as followed.

DST

Enable

Day of Week Date

Start: Jan 1st Mon 01 : 01 AM

End: Jan 1st Mon 01 : 01 AM

OK Cancel

Picture 4.14 DST (week)

DST

Enable

Day of Week Date

Start: 2012 - 01 - 01 01 : 01 AM

End: 2012 - 01 - 01 01 : 01 AM

OK Cancel

Picture 4.15 DST (date)

4.4.2 Encode setup

Set the video/audio code parameter: video file, remote monitoring and so on. Set every independent channel's coding parameter in the left part, and set the combine encode parameter in the right part.

Note: Combine encode introduces video compression technique which combines and compresses

multi-channel's video to a special channel. Applying for multi-channel playback simultaneously, Dial-up multi-channel real-time monitor, mobile monitor and so on.

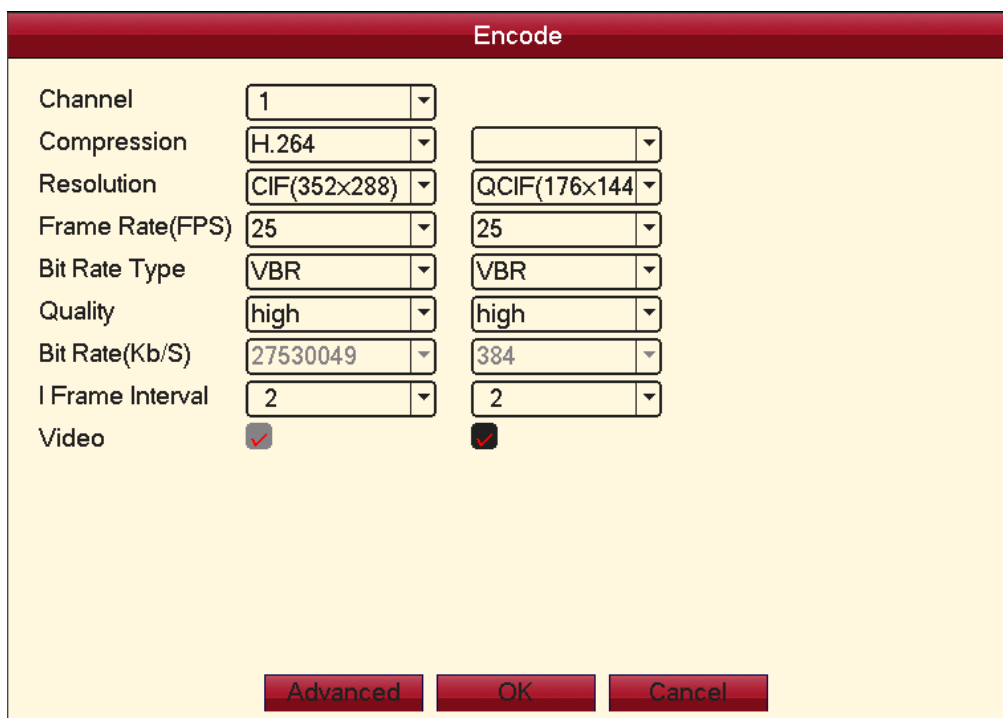

Picture 4.16 Encode setup

【Channel】 Choose the channel number.

【Compression】 Standard H.264 main profile.

【Resolution】 Resolution type:D1/ HD1/CIF / QCIF.

【Frame Rate】 P:1 frame/s~25 frame/s; N: 1 frame/s~30 frame/s

【Bit Rate Type】 You can choose limited code stream or variable code stream. When you choose the variable code stream there are six image quality options.

【Bit Rate】 Set the code stream value to modify the image quality. The larger code stream value the better image quality.

D1 (1000~1500kbps) ,CIF (384~1500kbps) , QCIF(64~512kbps)

【Video/Audio】 When the icons are all in reverse displayed, the video file is video and audio multiplex stream.

Combine Enable

【Combine Enable】 When the icons are all in reverse displayed, opening combination coding functions.

【Mode】 multi-channel playback is used in all channels playback simultaneously, and the

narrowband transmission is used in multi-channel real-time remote monitoring simultaneously at narrowband state, especially used in mobile monitor.

4.4.3 Network setup

Network

Net Card: Wire Netcard DHCP Enable

IP Address: 0 . 0 . 0 . 0

Subnet Mask: 0 . 0 . 0 . 0

Gateway: 0 . 0 . 0 . 0

Primary DNS: 202 . 118 . 232 . 108

Secondary DNS: 202 . 118 . 232 . 108

Media Port: 34567

HTTP Port: 80

HS Download:

Transfer Policy: Quality Preferr **NetService**

OK Cancel

Picture4.17 Network

【Net Card】 You can choose cable network card or wireless network card.

【DHCP Enable】 Obtain IP address automatically(not suggested)

Note: DHCP server is preinstalled.

【IP address】 Set the IP address. Default: 192.168.1.10.

【Subnet mask】 Set the subnet mask code. Default: 255.255.255.0.

【Gateway】 Set the default gateway. Default: 192.168.1.1.

【DNS setup】 Domain Name Server. It translates the domain name into IP address. The IP address is offered by network provider. The address must be set and reboot then it works.

【TCP port】 Default: 34567.

【HTTP port】 Default: 80.

【HS Download】

【Transfer Policy】 There are three strategies: self-adaption, image quality precedence and fluency precedence. The code stream will adjust according to the setup. Self-adaption is the tradeoff between

the image quality precedence and fluency precedence. Fluency precedence and self-adaption are valid only when the assistant code stream is turned on. Otherwise image quality precedence is valid.

4.4.4 NetService

Choose the network service option and click the set button to configure the advanced network functions or double click the service button to configure the parameters.

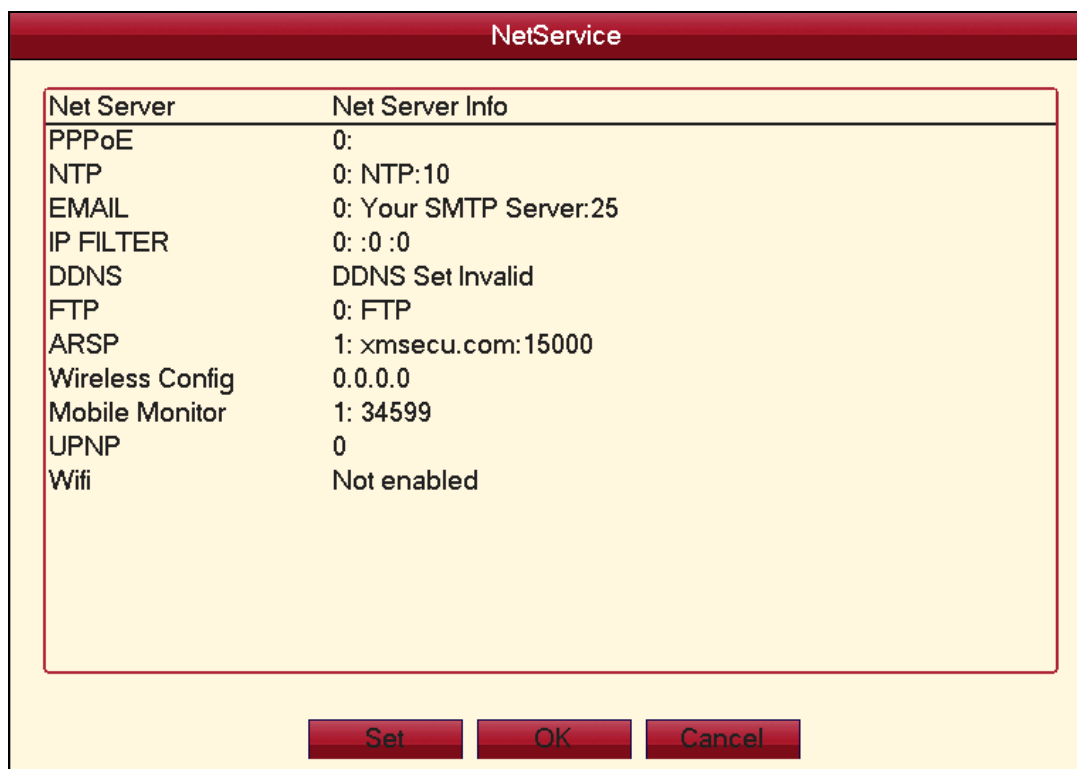

Picture 4.18 NetService

【PPPoE setup】

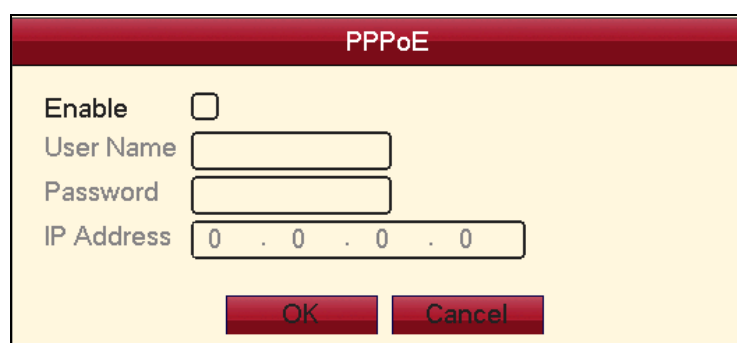

Picture4.19 PPPOE

Input the user name and password that ISP (Internet service provider) provides. After saving it reboot up your system. Then the DVR will build a network connection based on PPPoE. The IP address will change into dynamic IP address after above operation is well done.

Operation: After PPPoE dialing successfully look up the IP address in the [IP address] and obtain the current IP address. Then use this IP address to visit the DVR through user port.

【NTP setup】

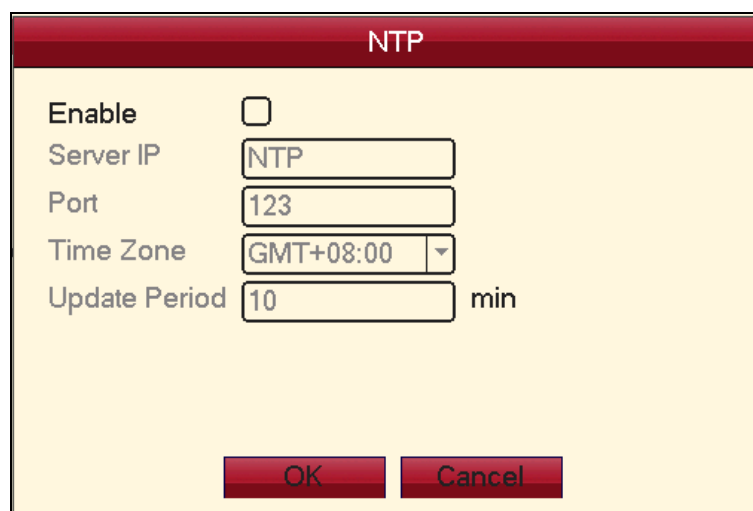

Picture 4.20 NTP

The NTP server must be installed in the PC.

Host computer IP: Input the IP address installed NTP server.

Port: Default: 123. You can set the port according to NTP server.

Time zone: London GMT+0 Berlin GMT +1 Cairo GMT +2 Moscow GMT +3 New Delhi GMT +5 Bangkok GMT +7 Hongkong Beijing GMT +8 Tokyo GMT +9 Sydney GMT +10 Hawaii GMT-10 Alaska GMT-9 Pacific time GMT-8 American mountain time GMT-7 American mid time GMT-6 American eastern time GMT-5 Atlantic time GMT-4 Brazil GMT-3 Atlantic mid time GMT-2.

Update Period: The same with the NTP server check interval. Default: 10minutes.

【EMAIL setup】

If the alarm is turned on or the alarm linkage photos are taken, send an email about the alarm information and the photos to appointed address.

Picture 4.21 EMAIL

SMTP server:Email server address. It could be an IP address or domain name. Domain name can be translated only it is the correct DNS configuration.

Port:Email server port number.

SSL:Decide whether using Secure Socket Layer protocol to login.

User Name:Apply the email server user name.

Password:Input the password corresponding to the user.

Sender:Set the email sender address.

Receiver:Send the email to appointed receivers when the alarm is turned on. You can set three receivers at most.

Title:You can set as you wish.

【IP Filter setup】

When choosing the white list, only the listed IP address can connect the DVR. The 64 IP addressed are supportive in the list.

When choosing the black list, the listed IP address can not connect the DVR. The 64 IP addressed are supportive in the list.

You can delete the set IP address by √ in the options.

Note: When the same IP address is in the white and black list at the same time, the black list precedence is higher.

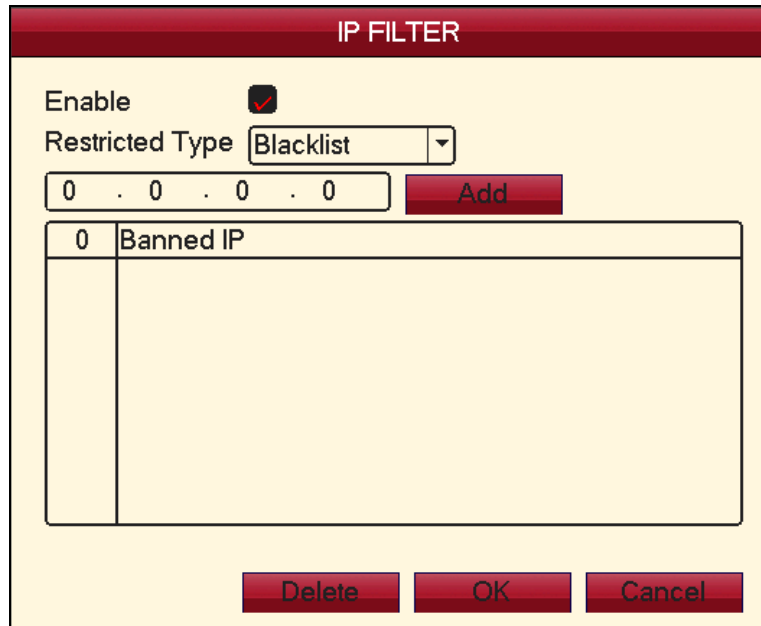

Picture 4.22 IP IP FILTER

【DDNS】

It is the abbreviation of dynamic domain name server.

Local domain name: Provide the domain name registered by DDNS.

User name: Provide the account registered by DDNS.

Password: Provide the password registered by DDNS.

When the DDNS is successfully configured and start, you can connect the domain name in the IE address column to visit.

Note: The DNS setup must be configured correctly in the network setup.

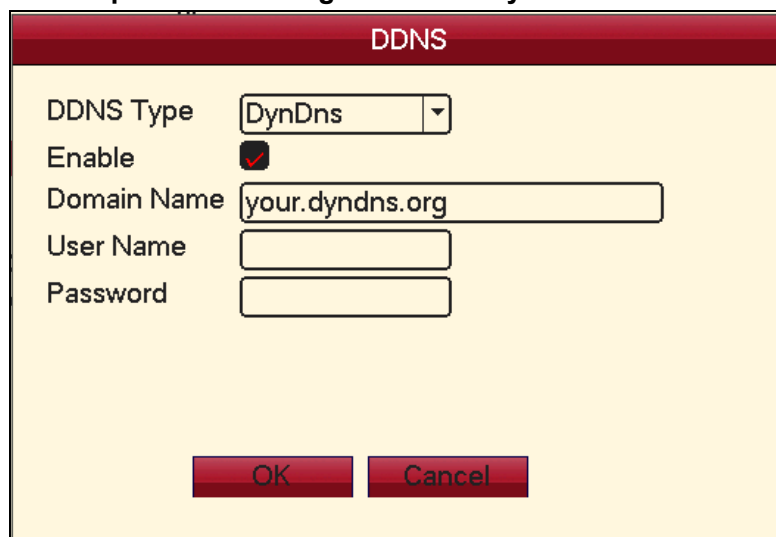

Picture 4.23 DDNS setup

【FTP setup】 FTP is available only when alarm happens, or alarm activates record and snapshot, it will upload related record and snapshot pictures to FTP server.

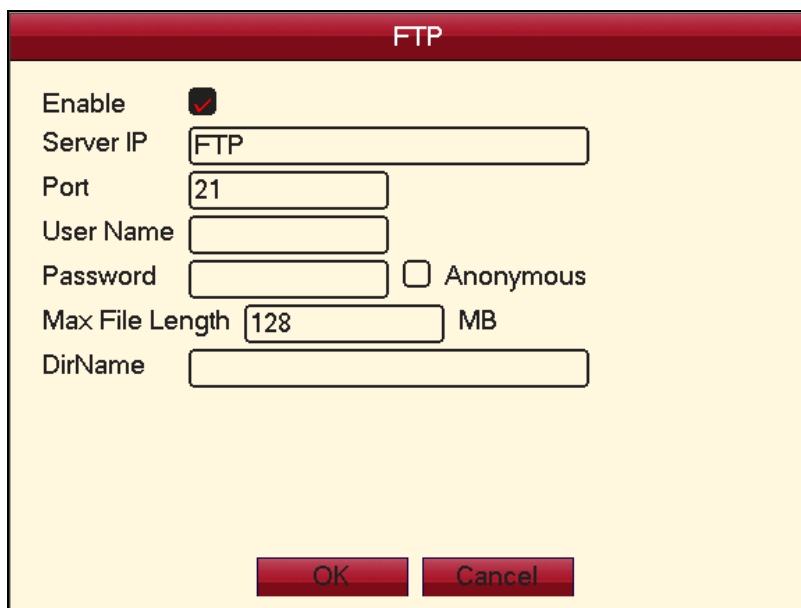

Picture 4.24 FTP setup

【Enable】 Click Enable, then all settings will be available

【Server IP】 IP address for FTP server

【Port】 Domain Port of FTP, default 21

【User Name】 User name of FTP

【Password】 Password of user

【Max File Length】 Max length for upload files at every packed, default 128M

【DirName】 Directory of uploading files

【Mobile Monitor Setup】

To visit the device by mobile, pls make a router mapping of this port and use CMS to monitor and operate it by protocol.

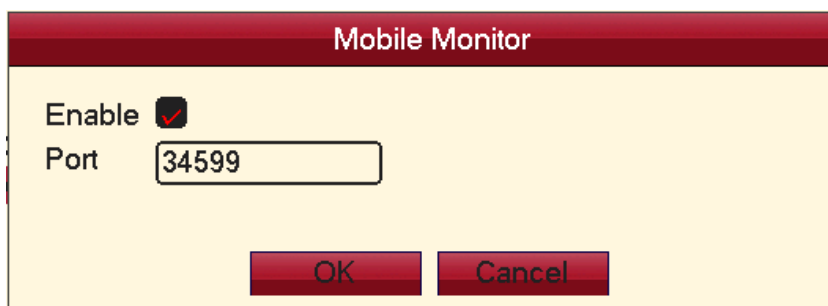

Picture 4.26 Mobile Monitor Setup

【Enable】 Select it to make sure abnormal function workable

【Port】 It's a port of mobile monitoring which you need to make a router mapping of if want to visit it by mobile

【UPNP】 UPNP protocol can auto port forwarding on router,make sure UPNP is running on router before use it.

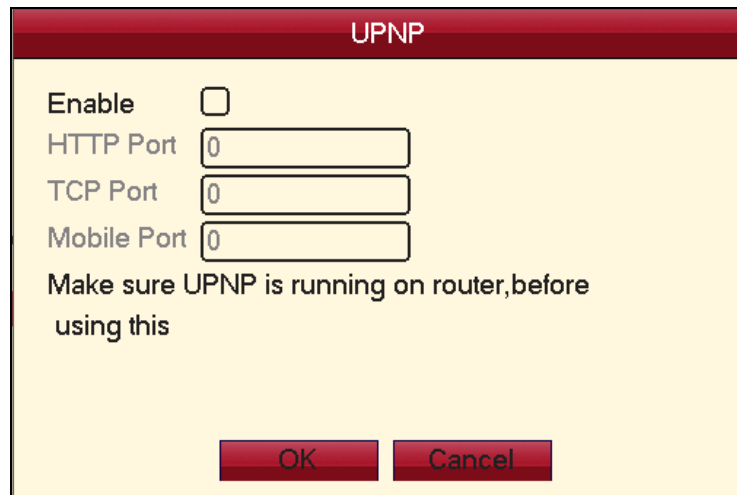

Picture 4.27

【Enable】 Choose Enable to make sure all UPNP settings available

【HTTP】 Route will automatically distribute HTTP port for the device,when IE viewing,it need this port(eg. 60.12.9.26:66)

【TCP】 Router will automatically distribute TCP port for the device,when monitoring via CMS,it need this port.

【MobilePort】 Router will automatically distribute Mobile Port for the device,when mobile monitor,it need this port.

4.4.5 GUI Display

Configure the video output parameters including the front output mode and code output mode.

Front output: In the local preview mode include: channel title, time display, channel title, record status, alarm status,bitrate info, transparency and region cover.

Code output: In the network surveillance and video file mode include: channel title, time display, channel title, record status, alarm status,bitrate info, transparency and region cover.

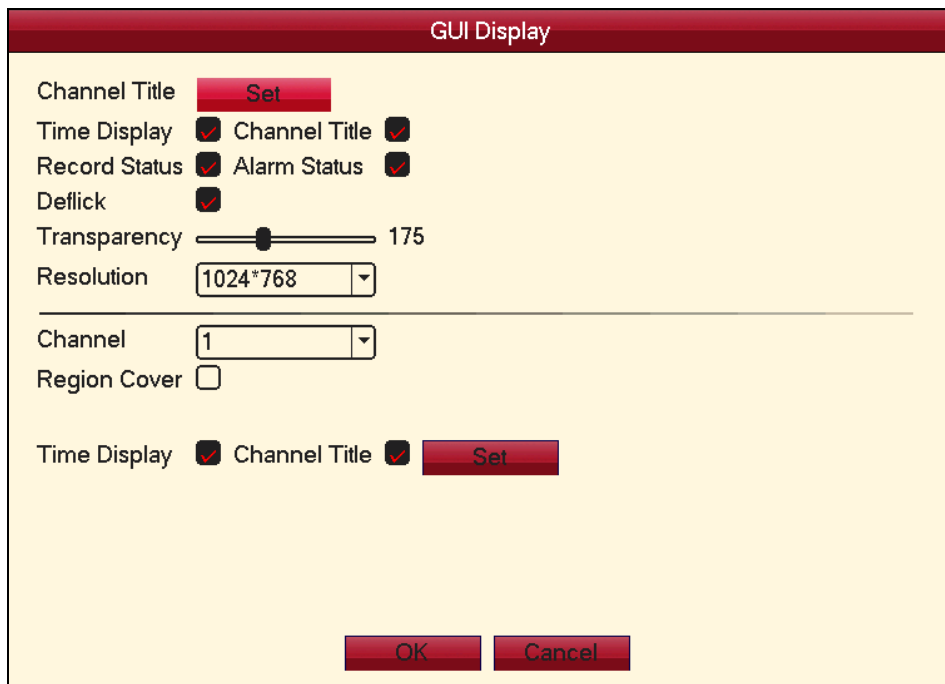

Picture 4.28 GUI Display

【Channel Title】 Click the channel name modify button and enter the channel name menu. Modify the channel name. The 16 Chinese characters and 25 letters are supportive.

【Time Display】 means the selective state. Display the system data and time in the surveillance window.

【Channel Title】 means the selective state. Display the system channel number in the surveillance window.

【Record Status】 means the selective state. Display the system recording status in the surveillance window.

【Alarm Status】 means the selective state. Display the system alarm status in the surveillance window.

【Bitrate info】 means the selective state. The ninth window displays the code stream information in the nine-window preview status.

【Transparency】 Choose the background image transparency. The range is 128~255.

【Resolution】 set display resolution.

【Channel】 Choose the set code output channel number.

【Region Cover】 means the selective state. Click the cover area button and enter the corresponding channel window. You can cover the arbitrary using mouse. (Black region is for output)

【Time display】 and **【Channel Title】**

4.4.6 PTZ setup

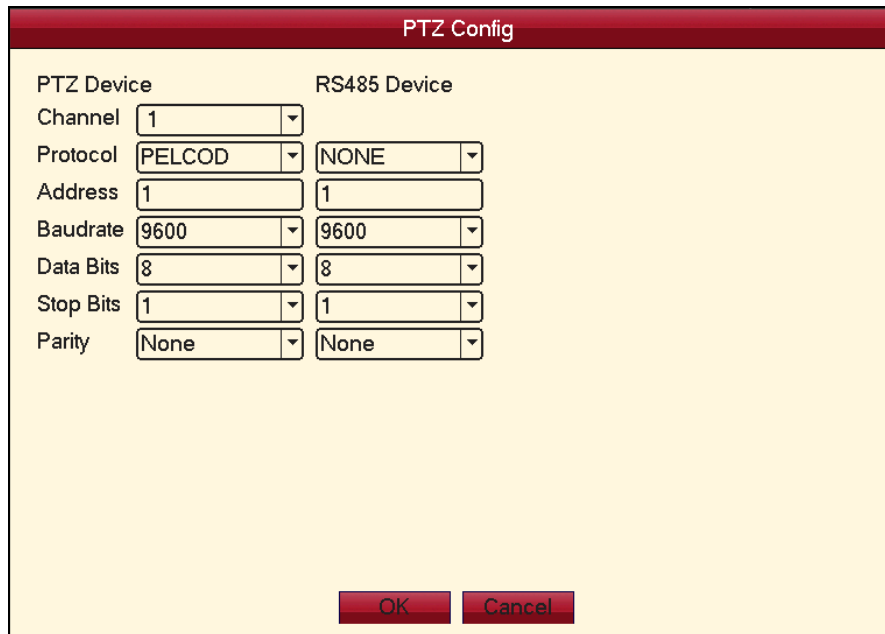

PTZ Device		RS485 Device	
Channel	1	Protocol	NONE
Address	1	Address	1
Baudrate	9600	Baudrate	9600
Data Bits	8	Data Bits	8
Stop Bits	1	Stop Bits	1
Parity	None	Parity	None

OK Cancel

Picture 4.29 PTZ setup

【Channel】 Choose the dome camera input channel.

【Protocol】 Choose the corresponding dome protocol. (PELCOD as an example)

【Address】 Set as the corresponding dome address. Default: 1. (Note: The address must be consistent with the dome address.)

【Baudrate】 Choose the corresponding dome baud rate length. You can control the PTZ and vidicon. Default: 115200.

【Data bits】 Include 5-8 options. Default: 8.

【Stop bits】 Include 2 options. Default: 1.

【Parity】 Include odd check, even check, sign check, blank check. Default: void.

4.5 Advanced

4.5.1 HDD Manage

Configure and manage the hard disk. The menu displays current hard disk information: hard disk number, input port, type, status and overall capability. The operation include: setup the write-read disk, read-only disk, redundant disk, hard disk format, resume default. Choose the hard disk and click the right function button to execute.

Note: Read/Write Disk: The equipment can write or read data.

Read-only Disk: The equipment can read data but can not write data.

Redundant Disk: Double backup the video files in the write-read disk.

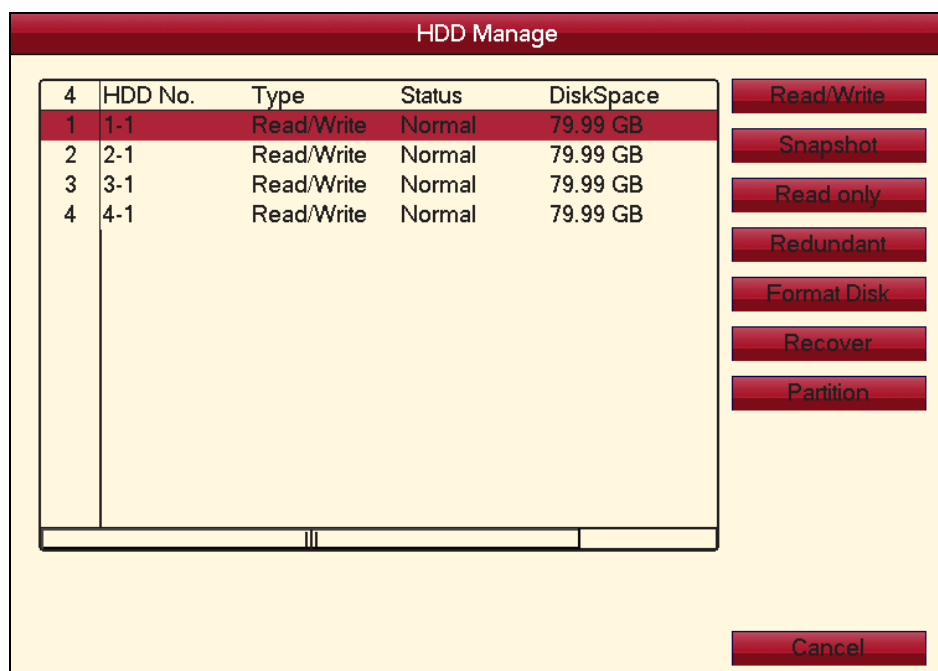

Picture4.32 HDD Manage

4.5.2 Account

Manage the user purview.

- Note:**
1. The character length is 8 bytes at most for the following user and user team name. The blank ahead or behind the character string is invalid. The middle blank in the character string is valid. Legal characters include: letter, number, underline, subtraction sign, dot.
 2. There is no limit in the user and user group. You can add or delete the user group according to user definition. The factory setup include: user\admin. You can set the team as you wish. The user can appoint the purview in the group.
 3. The user management include: group/ user. The group and user name can not be the same. Each user only belongs to one group.

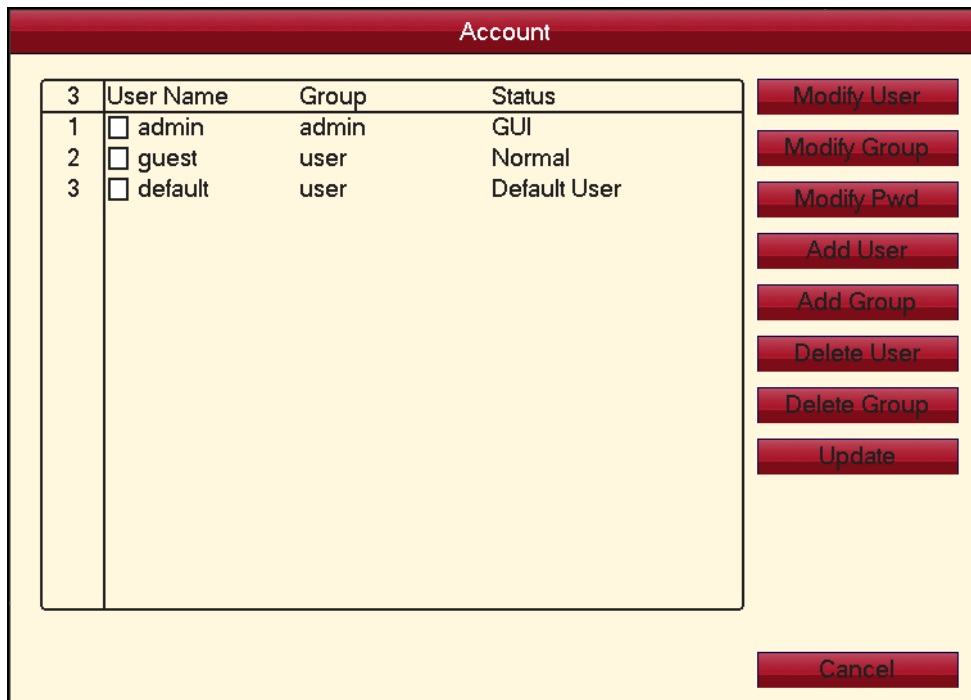

Picture 4.33 Account

【Modify User】 Modify the existed user attribute.

【Modify Group】 Modify the existed team attribute.

【Modify Password】 Modify the user password. You can set 1-6 bit password. The blank ahead or behind the char string is invalid. The middle blank in the char string is valid.

Note: The user who possess the user control purview can modify his/her own or other users password

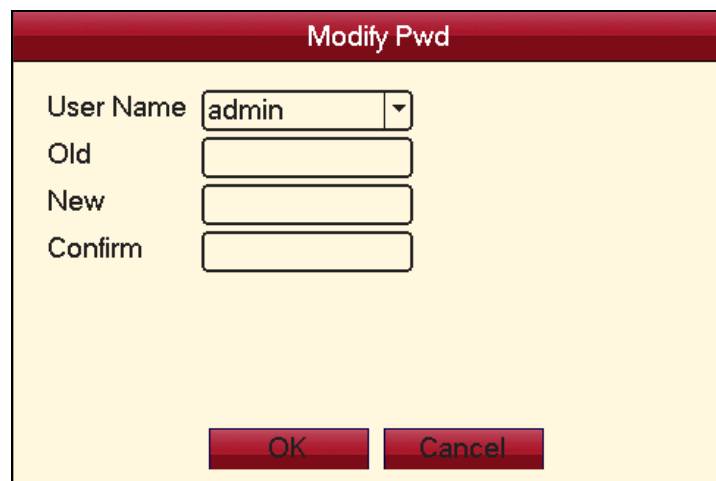

Picture 4.34 Modify Password

【Add user】 Add a user in the team and set the user purview. Enter the menu interface and input the user name and password. Choose the team and choose whether cover using the user. Cover using means that the account can be used by multiple users at the same time.

Once choose the team the user purview is the subclass of the team.

We recommend that the common user's purview is lower than the advanced user.

53		Authority
1	<input checked="" type="checkbox"/>	Shutdown the device
2	<input checked="" type="checkbox"/>	Channel Title
3	<input checked="" type="checkbox"/>	Schedule
4	<input checked="" type="checkbox"/>	Backup
5	<input checked="" type="checkbox"/>	HDD Management
6	<input checked="" type="checkbox"/>	Account
7	<input checked="" type="checkbox"/>	Query System Info
8	<input checked="" type="checkbox"/>	Query Log Info
9	<input checked="" type="checkbox"/>	Clear Log
10	<input type="checkbox"/>	System Update

Picture 4.35 add user

【Add Group】 Add a user team and set the purview. There are 36 different purviews: shut down the equipment, real time surveillance, playback, recording setup, video file backup and so on.

53		Authority
1	<input checked="" type="checkbox"/>	Shutdown the device
2	<input checked="" type="checkbox"/>	Channel Title
3	<input checked="" type="checkbox"/>	Schedule
4	<input checked="" type="checkbox"/>	Backup
5	<input checked="" type="checkbox"/>	HDD Management
6	<input checked="" type="checkbox"/>	Account
7	<input checked="" type="checkbox"/>	Query System Info
8	<input checked="" type="checkbox"/>	Query Log Info
9	<input checked="" type="checkbox"/>	Clear Log
10	<input checked="" type="checkbox"/>	System Update
11	<input checked="" type="checkbox"/>	Auto Maintain
12	<input checked="" type="checkbox"/>	General Config
13	<input checked="" type="checkbox"/>	Encode Config
14	<input type="checkbox"/>	PC222

Picture 4.36 Add Group

【Delete User】 Delete the current user. Choose the user and click delete user button.

【Delete Group】 Delete the current group. Choose the group and click delete group button.

The screenshot shows a dialog box titled "Delete Group". It contains three input fields: "GROUP" is a dropdown menu with "admin" selected; "Name" is a text box with "admin" entered; "Memo" is a text box with "administrator group" entered. At the bottom of the dialog are two buttons: "Delete" and "Cancel".

Picture 4.37 Delete Group

4.5.3 Online User

Look up the network user information in the local DVR. You can choose the network user and cut the connection. Then the user is locked until next boot-strap.

The screenshot shows a dialog box titled "Online User". It contains a table with the following headers: "User Name", "IP", and "Login Type". The table is currently empty. At the bottom of the dialog are two buttons: "Disconnect" and "Cancel".

Picture 4.38 Online User

4.5.4 TV adjust

Refer to chapter 3.5.7 .

4.5.5 Auto Maintain

The user can set the auto reboot time and auto file deleting time limit.

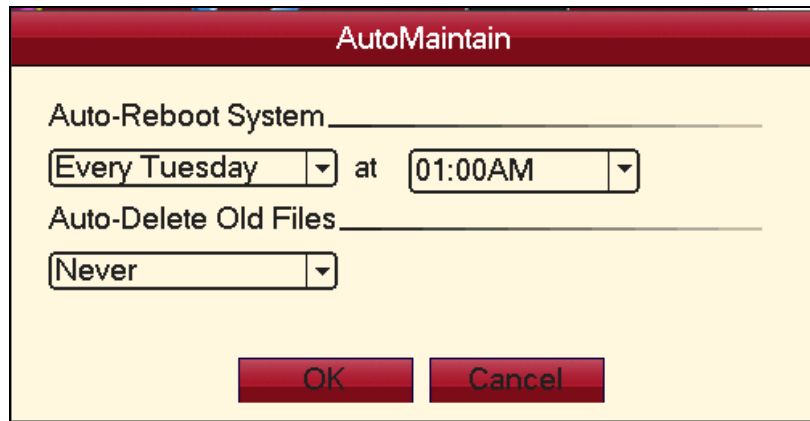

Picture 4.39 Auto maintain

4.5.6 Restore

The system restore to the default setup. You can choose the items according to the menu.

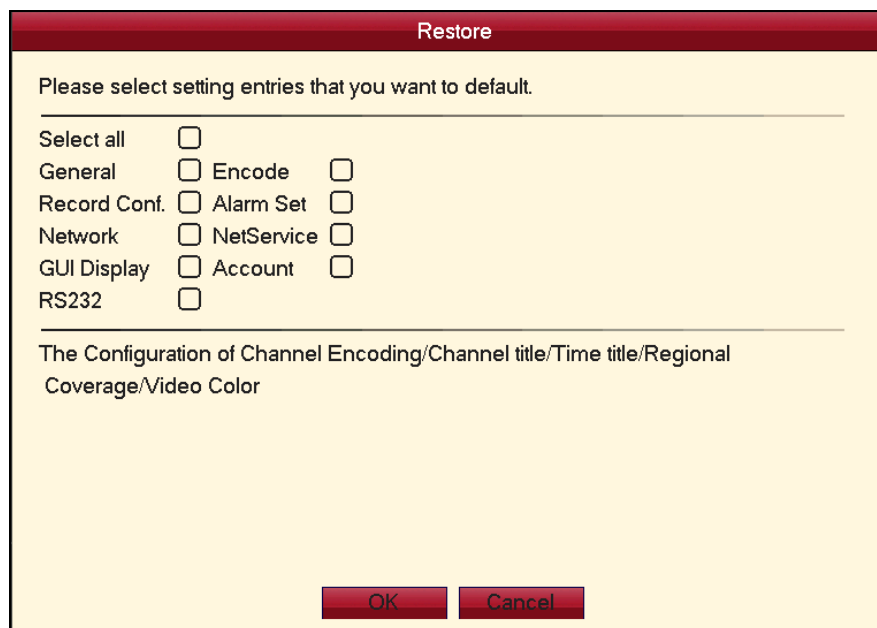

Picture 4.40 Restore

4.5.7 Upgrade

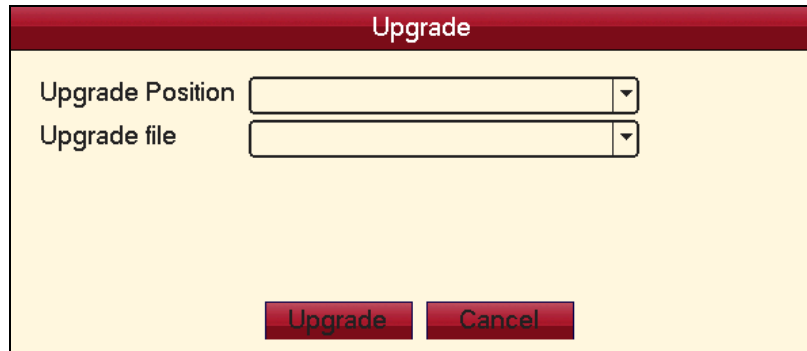

Picture 4.41 Upgrade

【Upgrade】 choose USB interface.

【Upgrade file】 choose the file which needs upgraded.

4.5.8 Device Info

Provide device interface info like audio in, alarm in/out to be conveniently used for user.

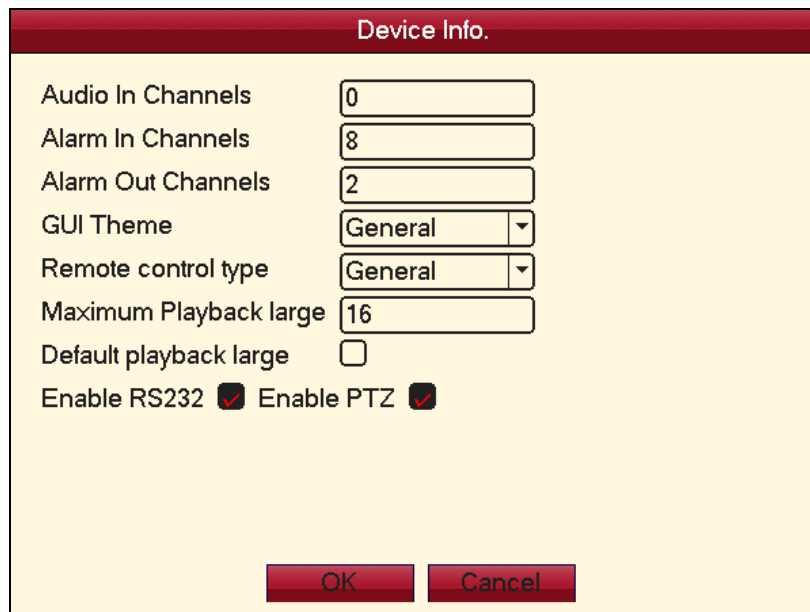

Picture 4.42 Device Info.

4.6 Info

4.6.1 HDD info

Display the hard disk state: hard disk type, overall capability, residual capability, the recording time and so on.

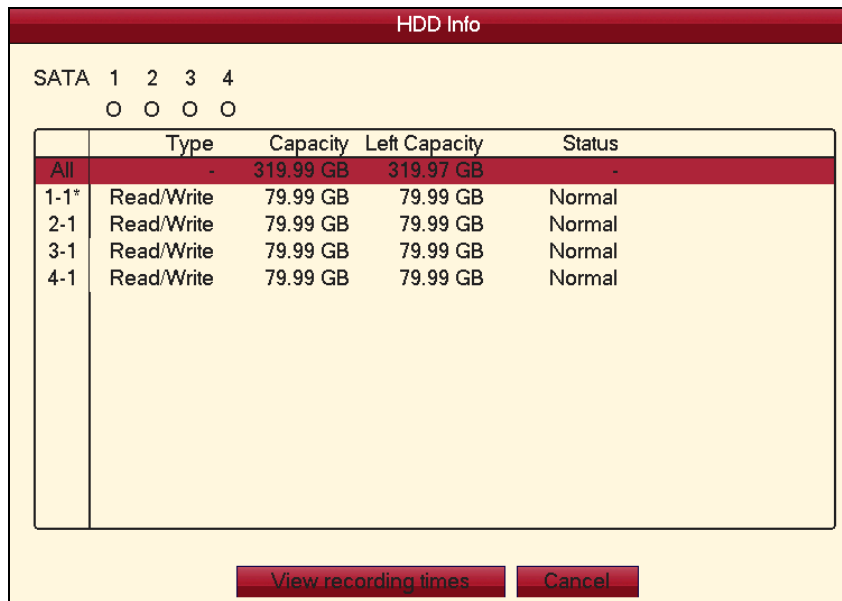

Picture 4.43 HDD Info

Clue: ○ means that the hard disk is normal. X means that the hard disk is broken-down. - means that there is no hard disk. If the user need to change the damaged hard disk, you must shut down the DVR and take up all the damaged hard disks, then install a new one.

* behind serial number means the current working disk such as 1*. If the corresponding disk is damaged, the information will show "?".

4.6.2 BPS

Display the code stream (Kb/S) and hard disk capability (MB/H) in real time. It displays as the wave sketch map.

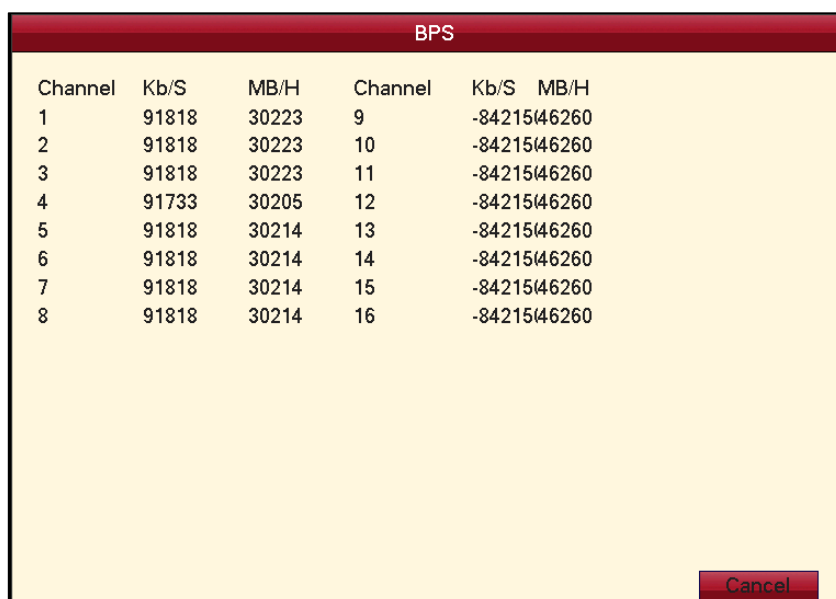

Picture 4.44 BPS

4.6.3 LOG

Look up system log according to the set mode.

Log information include: system operation, configuration operation, data management, alarm affair, recording operation, user management, file management and so on. Set the time section to look up and click the look up button. The log information will display as a list. (one page is 128 items) Press **Page up** or **Page down** button to look up and press **delete** button to clear all the log information.

The screenshot shows a web-based interface titled "LOG". At the top, there is a search section with a "Type" dropdown menu set to "All". Below this are "Start Time" and "End Time" input fields, both showing "2012 - 10 - 27 12 : 00 : 00 AM". To the right of these fields are "Search" and "Next Page" buttons. Below the search section is a table with the following data:

5	Log Time	Type	LOG
1	2012-10-27 02:42:11PM	save system state	2051- 3-06 12:51:12
2	2012-10-27 02:42:11PM	Log In	User default LogIn by GUI
3	2012-10-27 02:42:52PM	Log Out	User default LogOut by GUI
4	2012-10-27 02:42:52PM	Log In	User admin LogIn by GUI
5	2012-10-27 03:00:34PM	save system state	2012-10-27 14:58:41(2)

At the bottom right of the interface, there are "Remove" and "Cancel" buttons.

Picture4.45 LOG

4.6.4 Version

Display the basic information such as hardware information, software edition, issue data and so on.

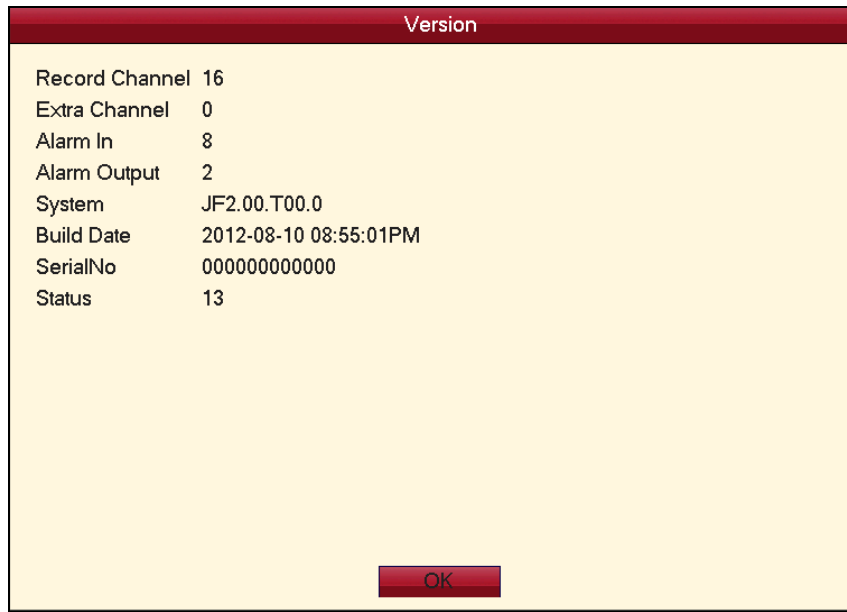

Picture 4.46 Version

4.7 Shut down system

Refer to chapter 3.5.8.



5 FAQ and maintenance

5.1 FAQ

If the problems are not listed, please contact the local service or call the HQ service. We are willing to offer the service.

1、 The DVR can not boot up normally.

Possible reasons are as followed:

- 1 The power supply is not correct.
- 2 Switch power supply line is not in good connection.
- 3 Switch power supply is damaged.
- 4 The program updating is wrong.
- 5 The hard disk is damaged or the hard disk lines are broken.
- 6 The front panel is damaged.
- 7 The main board of the DVR is damaged.

2、 The DVR reboots automatically or stops working after boot up a few minutes.

Possible reasons are as followed:

- 1 The input voltage is not stable or too low.
- 2 The hard disk is damaged or the hard disk lines are broken.
- 3 The power of the switch power supply is low.
- 4 Frontal video signal is not stable.
- 5 Bad heat radiator or too much dust or bad running circumstance for the DVR.
- 6 The hardware of the DVR is damaged.

3、 System can not detect hard disk.

Possible reasons are as followed:

- 1 The hard disk power supply line is not connected.
- 2 The cables of the hard disk are damaged.
- 3 The hard disk is damaged.
- 4 The SATA port of main board is damaged.

4、 There are no video outputs in single channel, multiple channels and all channels.

Possible reasons are as followed:

- 1 The program is not matched. Please update the program.
- 2 The image brightness is all 0. Please restore the default setup.
- 3 There is no video input signal or the signal is too weak.
- 4 The channel protection or the screen protection is set.
- 5 The hardware of the DVR is damaged.

5、 Real-time image problems such as the image color or the brightness distortion.

Possible reasons are as followed:

- 1 When using the BNC output, the option between the N mode or PAL mode is wrong and the image becomes black and white.
- 2 The DVR is not matched the monitor impedance.
- 3 The video transmission distance is too far or the loss of the video transmission line is too large.
- 4 The color and brightness setting of the DVR is wrong.

6、 I can not find the video files in local playback mode.

Possible reasons are as followed:

- 1 The data line of the hard disk is damaged.
- 2 The hard disk is damaged.
- 3 Update the different program with the origin program files.
- 4 The video files to look up are covered.
- 5 The recording is not on.

7、 The local video is not clear.

Possible reasons are as followed:

- 1 The image quality is too bad.
- 2 The reading program is wrong. Reboot up the DVR.
- 3 The data line of the hard disk is damaged.
- 4 The hard disk is damaged.
- 5 The hardware of the DVR is damaged.

8、 There is no audio signal in the surveillance window.

Possible reasons are as followed:

- 1 It is not an active tone arm.
- 2 It is not an active sound box.
- 3 The audio lines are damaged.
- 4 The hardware of the DVR is damaged.

9、 There is audio signal in the surveillance window but no audio signal in the playback state.

Possible reasons are as followed:

- 1 Setting issues: the audio option is not chosen.
- 2 The according channel is not connected with the video.

10、 The time is wrong.

Possible reasons are as followed:

- 1 Setting is wrong..
- 2 The battery is in bad connection or the voltage is too low.
- 3 The oscillation is damaged.

11、 The DVR can not control the PTZ.

Possible reasons are as followed:

- 1 There is something wrong with the frontal PTZ.
- 2 The setting, connection or the installation of the PTZ decoder is not correct.
- 3 The connections are not correct.
- 4 The PTZ setting of the DVR is not correct.
- 5 The protocols of the PTZ decoder and the DVR are not matched.
- 6 The address of the PTZ decoder and the DVR are not matched.
- 7 When multiple decoders are connected, the far port of the PTZ decoder line A(B) must connect a 120Ω resistance to reduce the reflection otherwise the PTZ control is not stable.
- 8 The distance is too far.

12、 The motion detect is not working,

Possible reasons are as followed:

- 1 The time range set is not correct.
- 2 The motion detect area set is not correct.

- 3 The sensitivity is too low.
- 4 Limited by some hardware edition.

13、 I can not login via web or CMS.

Possible reasons are as followed:

- 1 The system is windows 98 or win me. We recommend updating to windows 2000sp4 or higher Version or installing the software for low edition.
- 2 ActiveX is hold back.
- 3 The version is not exceeded dx8.1. Update the display card driver.
- 4 Network connection failure.
- 5 Network setting issues.
- 6 Invalid password or user name.
- 7 The CMS is not matched the DVR program version.

14、 The image is not clear or there is no image in network preview state or video file playback state.

Possible reasons are as followed:

- 1 Network is not stable.
- 2 The user machine is resource limited.
- 3 Choose the play-in-team mode in the network setup of DVR.
- 4 The region shelter or channel protection is set.
- 5 The user has no surveillance purview.
- 6 The real-time image of the hard disk recording machine itself is not clear.

15、 Network connection is not stable.

Possible reasons are as followed:

- 1 Network is not stable.
- 2 IP address is conflicted.
- 3 MAC address is conflicted.
- 4 The net card of the DVR is bad.

16、 There is something wrong with the USB backup or writing a CD.

Possible reasons are as followed:

- 1 The rewritable machine and the hard disk are shared the same data lines.

- 2 The data is too much. Please stop recording and backup.
- 3 The data exceeds the backup storage.
- 4 The backup equipment is not compatible.
- 5 The backup equipment is damaged.

17、 The keyboard can not control the DVR.

Possible reasons are as followed:

- 1 The serial port of the DVR is not set correctly.
- 2 The address is not correct.
- 3 When multiple transformers are connected, the power supply is not large enough. Please give each transformer individual power supply.
- 4 The distance is too far.

18、 Alarm can not be recessional.

Possible reasons are as followed:

- 1 The setting of the alarm is not correct.
- 2 The alarm output is turned on manually.
- 3 The input machine is damaged or the connections are not correct.
- 4 There are some problems for specific program edition, Please update the program.

19、 Alarm is not working.

Possible reasons are as followed:

- 1 The setting of the alarm is not correct.
- 2 The connection of the alarm is not correct.
- 3 The alarm input signal is not correct.
- 4 A alarm is connected with two loops synchronously.

20、 The remote controller is not working,

Possible reasons are as followed:

- 1 The remote control address is not correct.
- 2 The remote control distance is too far or the angle is too large.
- 3 The battery is used up.
- 4 The remote controller or the front panel of the recording machine is damaged.

21、 The storage time is not enough.

Possible reasons are as followed:

- 1 Front vidicon quality is bad. The lens is too dirty. The vidicon is in backlighting installation.
- 2 The hard disk capability is not enough.
- 3 The hard disk is damaged.

22、 The downloading files can not play.

Possible reasons are as followed:

- 1 There is no media player.
- 2 There is no DX8.1 software or higher edition.
- 3 There is no DivX503Bundle.exe file to play AVI video files.
- 4 The DivX503Bundle.exe and ffdshow-2004 1012 .exe files must be installed in the windows xp system.

23、 I can not remember the advanced code or network code in the local menu operation.

Please contact the local service or call the HQ service. We will offer the service according the machine type and the program edition.

5.2 Maintenance

- 1 Please brush printed circuit boards, connectors, fans, machine box and so on regularly.
- 2 Please keep the grounding well done to prevent the video or audio signal interfered and the DVR from static or inductive electricity.
- 3 Do not pull out the video signal line or RS-232 port or RS-485 port with the power on.
- 4 Do not use the TV in the local video output port(VOUT) of DVR. It will damage the video output circuit easily.
- 5 Do not turn off the switch directly. Please use the turn-off function in the menu or press the turn-off button in the panel (3 seconds or longer) to protect the hard disk.
- 6 Please keep the DVR away from heat resource.
- 7 Please keep the DVR ventilated for better heat radiator.

Please check the system and maintain regularly.

Appendix 1.Remote controller operation

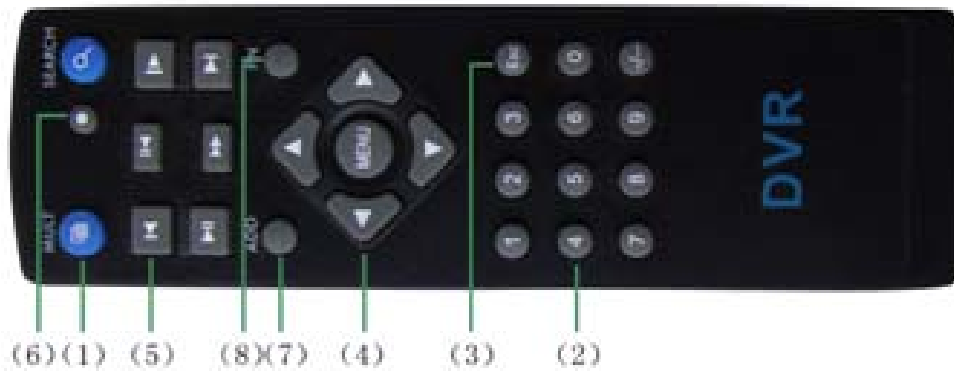

Serial number	Name	Function
1	Multi-window button	Same function as Multi-window button in the front panel
2	Numeric button	Code input/number input/channel switch
3	【Esc】	Same function as 【Esc】 button in the front panel
4	Direction button	Same function as direction button in the front panel
5	Record control	Control the record
6	Record mode	Same function as “Record mode”
7	ADD	Input the number of DVR to control it
8	FN	Assistant function

Appendix 2. Mouse operation

***Take right hand as an example**

The mouse in USB connection is supported.

Operation	Function
Double left click	Double click one item in the file list to playback the video
	Double click the playback video to zoom in or out the screen
	Double click the channel to make it full screen display double click again to resume the multi-window display
Left click	Choose the according function in the menu
Right click	Pop desktop shortcut menu in preview state
	Current shortcut menu in the menu
Press middle button	Add or subtract number in the number setting
	Switch the items in the combo box
	Page up or down in the list
Move mouse	Choose the widget or move the item in the widget
Drag mouse	Set the motion detect area
	Set the cover area

Appendix 3.Hard disk capability calculation

Make sure the hard disk installed to the DVR for the first time. Pay attention to the IDE hard disk lines connection.

1、 Hard disk capability

There is no limit for recording machine. We recommend 120G~250G size to keep better stability.

2、 Overall capability option

The hard disk capability formula is:

Overall capability (M) =channel number*time (hour) *capability in an hour (M/hour)

The recording time formula is:

$$\text{Recording time (hour)} = \frac{\text{overall capability (M)}}{\text{Capability in an hour (M/hour) *channel number}}$$

The DVR introduces the H.264 compression technology. Its dynamic range is very large so the hard disk capability calculation is based on the estimation values of each channel creating files in an hour.

Example:

For one piece 500G HDD,real time CIF for recording,it will keep recording for about 25 days.HDD spaces per channel is 200M/H,if 4channels real time CIF at 24hours recording uninterrupted,it can last:500G/(200M/H*24H*4ch)=26 days

Appendix 4. Technique parameters

	Type	4ch	8ch	16ch
System	Main processor	High performance embedded microprocessor		
	Operation system	Embedded LINUX operation system		
	System resource	synchronous multi-channel recording, synchronous multi-channel sub-code stream, synchronous multi-channel playback, synchronous network operation		
Interface	Operation interface	16 bit true color graphical menu interface, mouse operation supportive		
	display	1/4image display	1/4/8/9 image display	1/4/8/9/16 image display
Video	Video standard	PAL 625line,50 f/s;NTSC 525 line,60 f/s		
	Surveillance image quality	PAL, D1(704x576);NTSC, D1(704x480)		
	Playback image quality	PAL,D1(704×576);NTSC, D1(704*480)		
	Video compression	H.264 mp		
	Video control	6 options		
	Recording speed	100/120fps (D1)	200/240fps(CIF), 50/60fps D1	400/480fps CIF
	Motion detect	64(8×8) detection areas, multiple sensitivity		
Audio	Audio compression	G711A		
	Bidirectional Talk	Support		

Record And Playback	Recording mode	manual >alarm>motion detect>timing		
	Playback	Any channels playback, multiple channels playback		
	Search mode	Time searching, calendar searching, affair searching, channel searching, information searching		
Storage And backup	Space Occupation	Audio: 28.8MB/H Video:25~450MB/H		
	Recording storage	Hard disk, network		
	Backup mode	Network, USB flash,USB movable HDD,USB DVD-RW		
Port	Video input	4 BNC	8 BNC	16 BNC
	Video output	1 BNC, 1 VGA		
	Audio input	4 RCA		1 RCA
	Audio output	1 RCA		
	Network port	RJ45 10M/100M		
	PTZ control port	1 RS485		
	USB port	2* USB2.0 ports		
	Hard disk port	1 SATA port		
Other	Power supply	12V/2A external power supply		
	Power consumption	<15W (without hard disk)		
	Working temperature	0℃~+55℃		
	Working humidity	10%—90%		
	Air pressure	86kpa—106kpa		
	Size	260*200*43mm		
	Weight	2kg (without hard disk)		
	Installation	Desktop		

